

# DSE5

## DIRECTIONAL VALVE WITH PROPORTIONAL CONTROL

### SERIES 10

**SUBPLATE MOUNTING  
ISO 4401-05 (CETOP 05)**

**p max 320 bar**  
**Q max 90 l/min**

#### MOUNTING INTERFACE

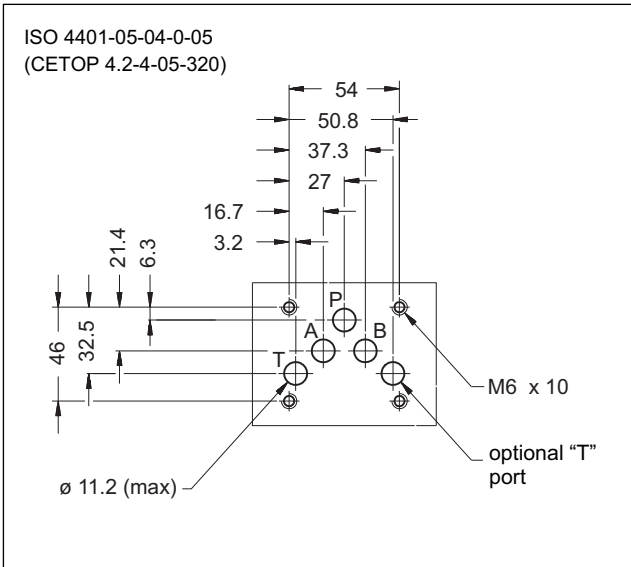

#### OPERATING PRINCIPLE

- The DSE5 valve is a directly operated directional control valve with electric proportional control and with ports in compliance with ISO 4401 standards (CETOP RP 121H).
- It is used for directional and speed control of the hydraulic actuators.
- Valve opening and hence flow rate can be modulated continuously in proportion to the current supplied to the solenoid.
- The valve can be controlled directly by a current control supply unit or by means of the relative electronic control units to exploit valve performance to the full (see paragraph 11).
- The DSE5 valve is available in special version with Y external subplate drain port (see paragraph 9).

#### PERFORMANCES

(obtained with mineral oil with viscosity of 36 cSt at 50°C and electronic control cards)

Maximum operating pressure: - P - A - B ports - T port : standard version version with Y port	bar	320 210 320
Maximum flow with $\Delta p$ 10 bar P-T	l/min	30 - 60
Step response	see paragraph 6	
Hysteresis (with PWM 100 Hz)	% of Q max	< 6%
Repeatability	% of Q max	< $\pm 1,5\%$
Electrical characteristics	see paragraph 5	
Ambient temperature range	°C	-20 / +60
Fluid temperature range	°C	-20 / +80
Fluid viscosity range	cSt	10 ÷ 400
Fluid contamination degree	According to ISO 4406:1999 class 18/16/13	
Recommended viscosity	cSt	25
Mass: single solenoid valve double solenoid valve	kg	4,4 5,9

#### HYDRAULIC SYMBOLS (typical)

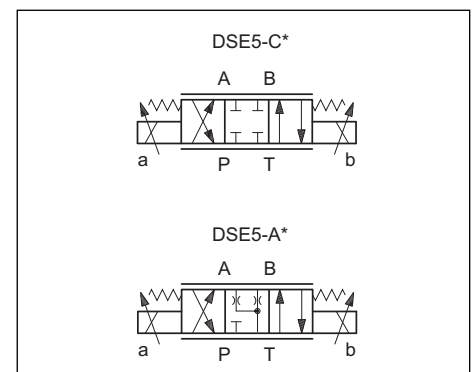

**1 - IDENTIFICATION CODE**

D	S	E	5	-				/	10	-		K1		
---	---	---	---	---	--	--	--	---	----	---	--	----	--	--

Directly operated directional control valve

Electric proportional control

Size ISO 4401-05 (CETOP 05)

Spool type:  
C = closed centers  
A = open centers

Spool nominal flow (see table 2)

Solenoid position (omit for configuration with two solenoids):  
SA = 1 solenoid on side A  
SB = 1 solenoid on side B

Manual override (see par. 10)

Coil electrical connection: plug for connector type DIN 43650 (**standard**)

**D12** = Nominal solenoid voltage 12V DC  
**D24** = Nominal solenoid voltage 24V DC

Seals:  
N = NBR seals for mineral oil (**standard**)  
V = FPM seals for special fluids

Series No. (from 10 to 19 sizes and mounting dimensions remain unchanged)

**2 - CONFIGURATIONS**

Valve configuration depends on the combination of the following elements:  
number of proportional solenoids, spool type, nominal flow rate.

2 solenoids configuration:  
3 positions with spring centering

“SA” configuration: 1 solenoid on side A.  
2 positions (central + external) with spring centering

“SB” configuration: 1 solenoid on side B.  
2 positions (central + external) with spring centering

*	Controlled flow with $\Delta p$ 10 bar P-T
30	30 l/min
60	60 l/min
60/30	60 (P-A) / 30 (B-T) l/min

**3 - CHARACTERISTIC CURVES** (values measured with viscosity of 36 cSt at 50°C with valves connected to the relative electronic control units)

Typical constant flow rate control curves at  $\Delta p$  according to current supply to solenoid (D24 version, maximum current 1600 mA), measured for the various spool types available. The reference  $\Delta p$  values are measured between ports P and T on the valve.

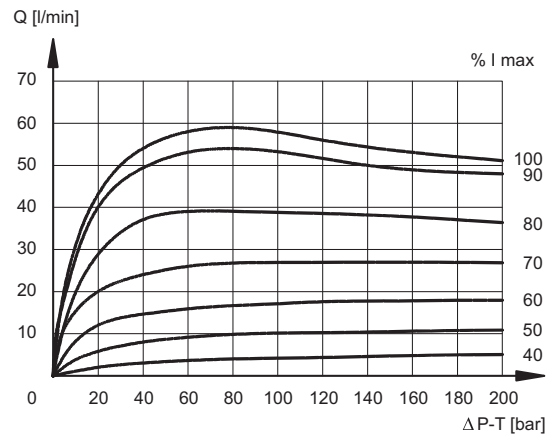
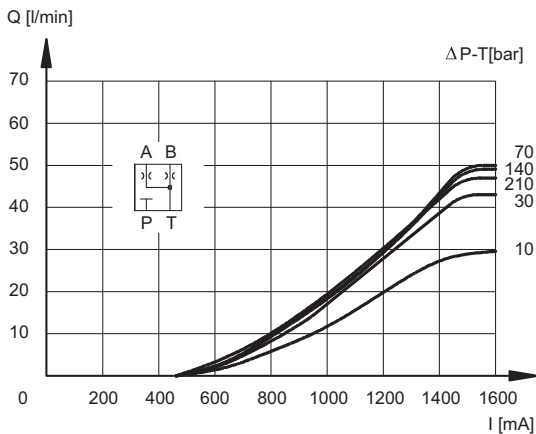
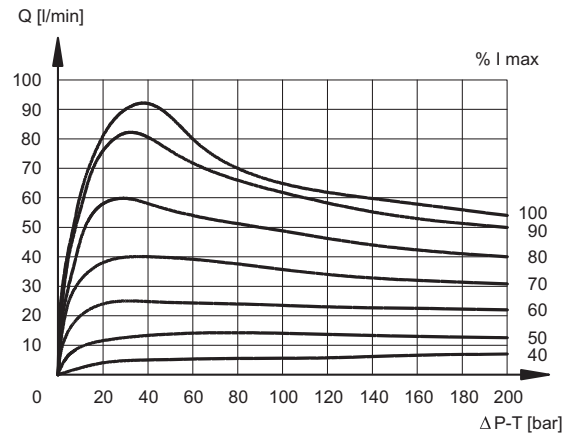
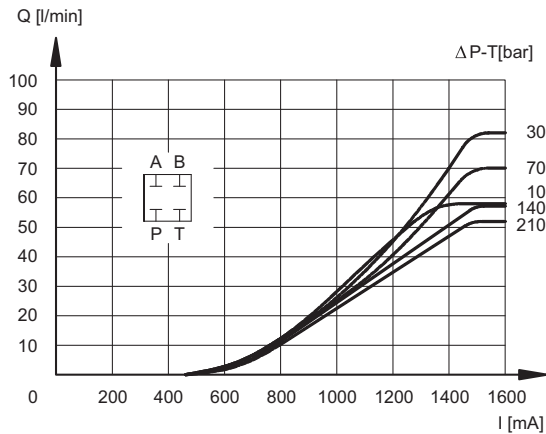
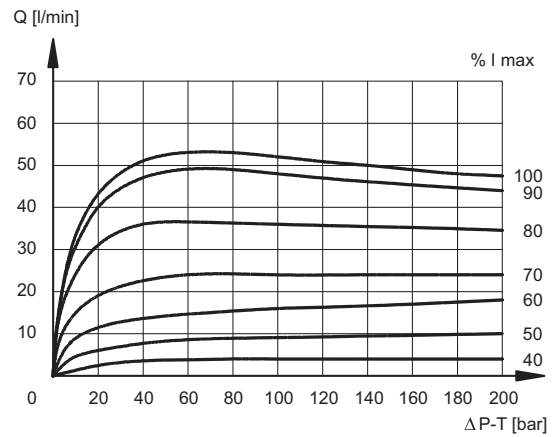
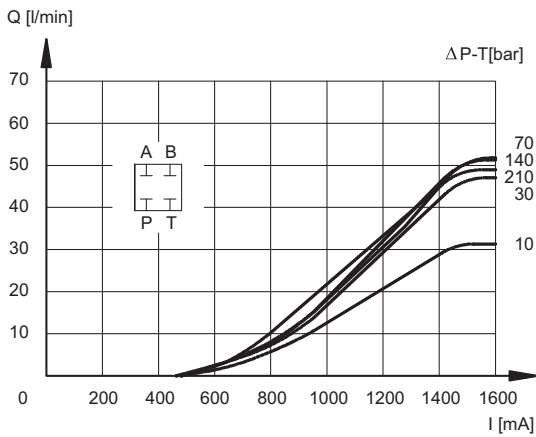
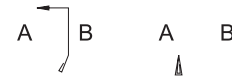

**SPOOL TYPE A60**

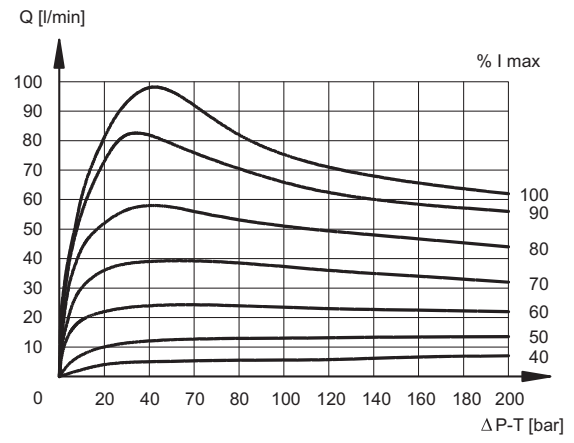
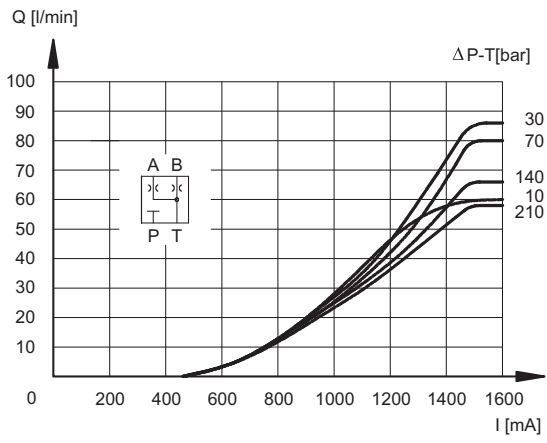

#### 4 - HYDRAULIC FLUIDS

Use mineral oil-based hydraulic fluids HL or HM type, according to ISO 6743-4. For these fluids, use NBR seals (code N). For fluids HFDR type (phosphate esters) use FPM seals (code V). For the use of other fluid types such as HFA, HFB, HFC, please consult our technical department. Using fluids at temperatures higher than 80 °C causes a faster degradation of the fluid and of the seals characteristics. The fluid must be preserved in its physical and chemical characteristics.

#### 5 - ELECTRICAL CHARACTERISTICS

##### Proportional solenoid

The proportional solenoid comprises two parts: tube and coil.

The tube, screwed to the valve body, contains the armature which is designed to maintain friction to a minimum thereby reducing hysteresis.

The coil is mounted on the tube secured by means of a lock nut.

It can be rotated through 360° depending on installation clearances.

<b>NOMINAL VOLTAGE</b>	VDC	<b>12</b>	<b>24</b>
<b>RESISTANCE (at 20°C)</b>	Ω	3 - 3.4	8.65
<b>MAXIMUM CURRENT</b>	A	2.6	1.6
<b>DUTY CYCLE</b>	100%		
<b>ELECTROMAGNETIC COMPATIBILITY (EMC)</b>	according to 2004/108/CE		
<b>CLASS OF PROTECTION:</b> atmospheric agents (CEI EN 60529) coil insulation (VDE 0580) Impregnation	IP 65 class H class F		

##### 6 - STEP RESPONSE (measured with mineral oil with viscosity of 36 cSt at 50°C with the relative electronic control units)

Step response is the time taken for the valve to reach 90% of the set position value following a step change of reference signal.

The table shows typical response times tested with spool type C60 and  $\Delta p = 20$  bar P-T.

<b>REFERENCE SIGNAL STEP</b>	0→100%	100%→0
Step response [ms]		
<b>DSE5-A*</b> <b>DSE5-C*</b>	50	40

#### 7 - INSTALLATION

DSE5 valves can be installed in any position without impairing correct operation.

Ensure that there is no air in the hydraulic circuit.

Valves are fixed by means of screws or tie rods on a flat surface with planarity and roughness equal to or better than those indicated in the relative symbols. If minimum values are not observed fluid can easily leak between the valve and support surface.

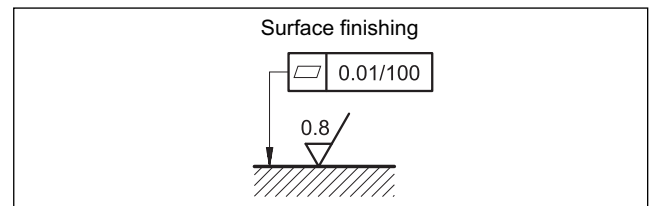

**8 - OVERALL AND MOUNTING DIMENSIONS**

**DSE5-A\*  
DSE5-C\***

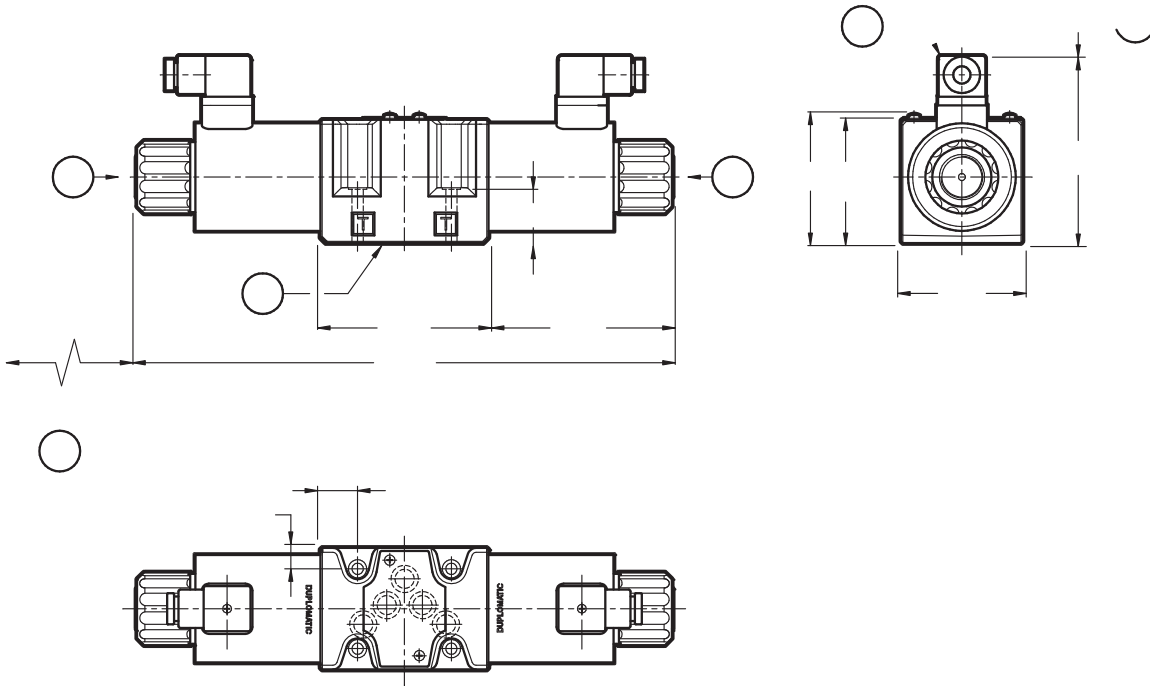

**DSE5-A\*SA  
DSE5-C\*SA**

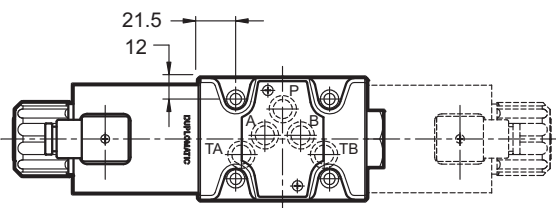
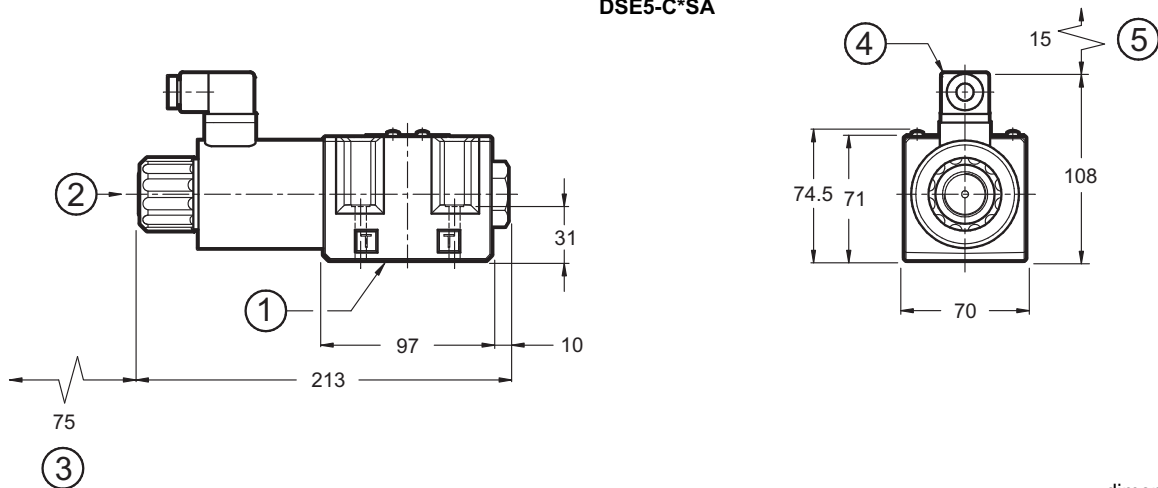

A\*SB and C\*SB versions solenoid position

dimensions in mm

1	Mounting surface with sealing rings: 5 OR type 2050 (12.42x1.78) - 90 Shore
2	Standard manual override integrated in the solenoid tube
3	Coil removal space
4	DIN 43650 electric coil connector
5	Connector removal space

Fastening bolts: 4 bolts M6x40 - ISO 4762  
Torque: 8 Nm (bolts A 8.8)

**9 - SPECIAL VERSION WITH Y EXTERNAL SUBPLATE DRAIN PORT**

**Identification Code**

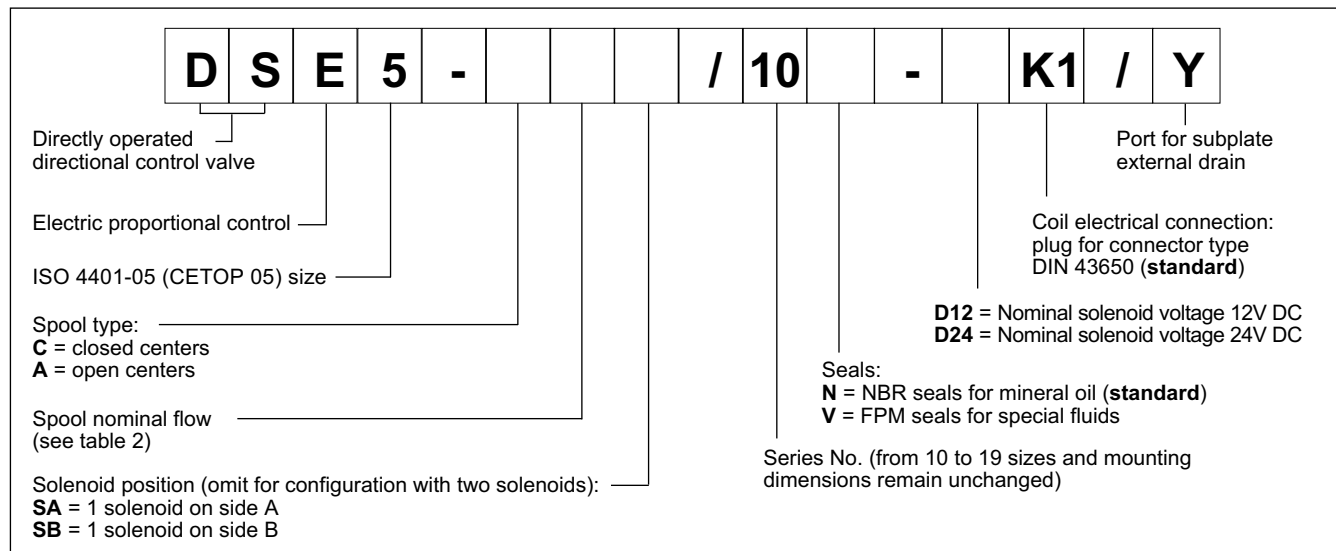

This version allows the operation with pressures up to 320 bar on the valve T port.

It is a drain port Y realized on the valve mounting interface in compliance with ISO 4401-05-05-0-05 (CETOP 4.2-4-R05). The Y port is connected with the solenoid chamber: in this way the tubes are not stressed by the pressure operating on the valve T port.

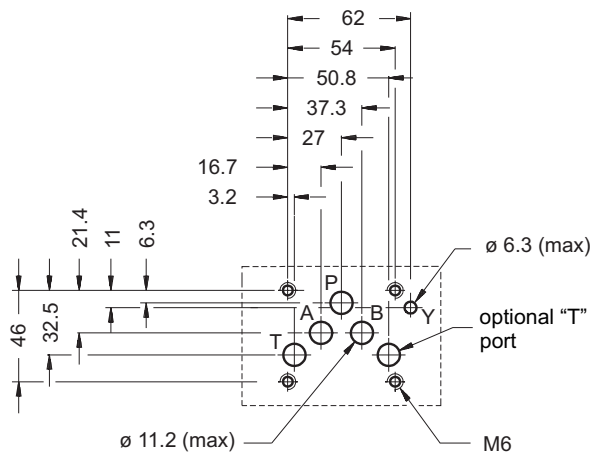

## 10 - MANUAL OVERRIDE

The standard valve has solenoids whose pin for the manual operation is integrated in the tube. The operation of this control must be executed with a suitable tool, minding not to damage the sliding surface.

The following manual override is available upon request:

- **CK** version, knob. When the set screw is screwed and its point is aligned with the edge of the knob, tighten the knob till it touches the spool: in this position the override is not engaged and the valve is de-energized. After adjusting the override, tighten the set screw in order to avoid the knob loosening.

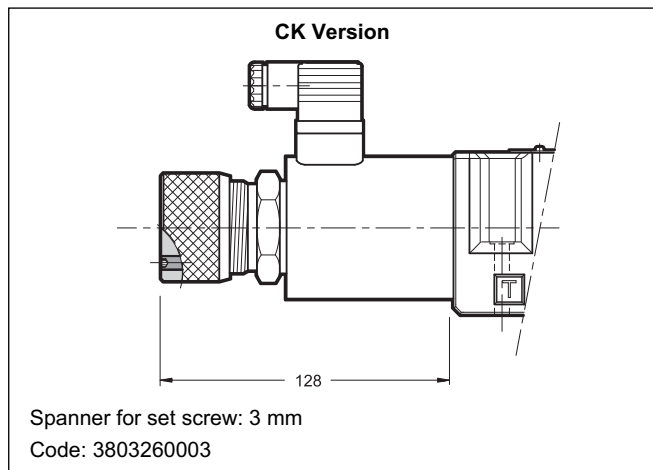

## 11 - ELECTRONIC CONTROL UNITS

### DSE5- \*\*SA (SB)

<b>EDC-131</b>	for solenoid 24V DC	plug version	see cat.89 120
<b>EDC-151</b>	for solenoid 12V DC		
<b>EDM-M131</b>	for solenoid 24V DC	DIN EN 50022 rail mounting	see cat. 89 250
<b>EDM-M151</b>	for solenoid 12V DC		

### DSE5- A\*    DSE5-C\*

<b>EDM-M231</b>	for solenoid 24V DC	DIN EN 50022 rail mounting	see cat. 89 250
<b>EDM-M251</b>	for solenoid 12V DC		

## 12 - SUBPLATES (see cat. 51 000)

Type PMD4-AI4G with rear ports 3/4" BSP
Type PMD4-AL4G with side ports 1/2" BSP