

Findynamica

drive and control products

Persslangkoppelingen
R1A, R1AT, R2A, R2AT en 4SP

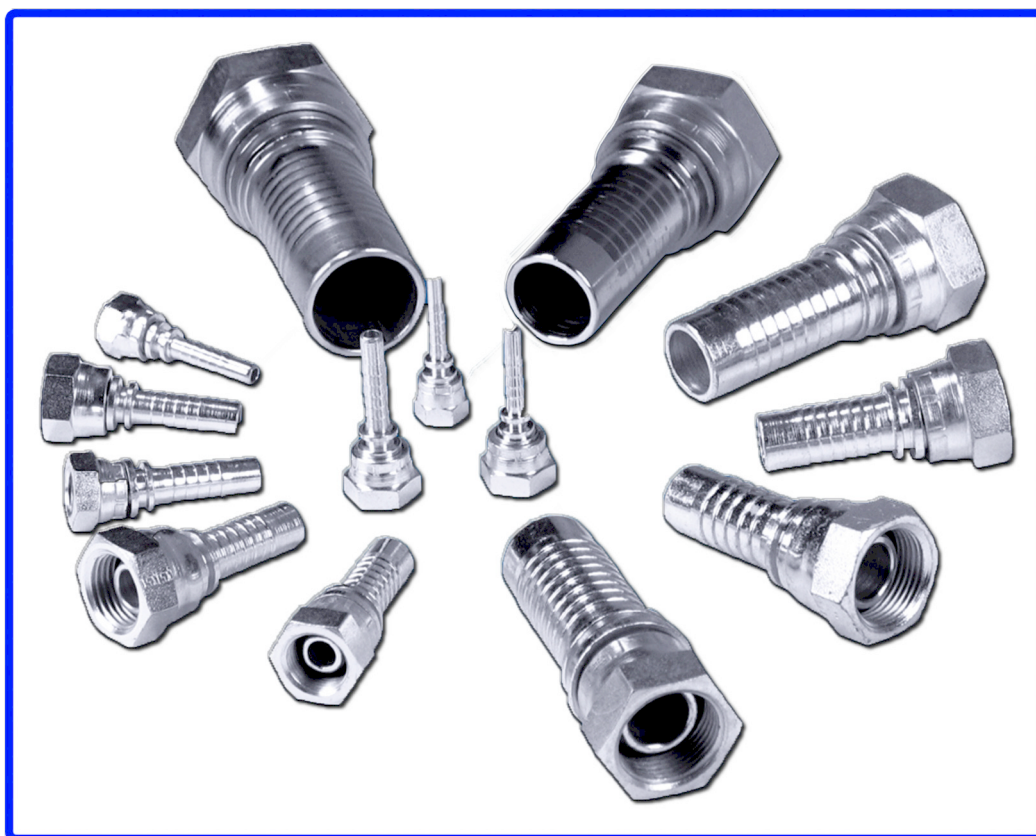

Persen van slangen met behulp van perskalibers

Om een hydrauliek slang op de juiste wijze te persen is het belangrijk dat u de onderstaande stappen opvolgt.

Stap 1:

Selecteer de slang (A), pershuls (B) en de persslangkoppeling (C) uit de catalogus van Oudshoorn Hydraulics. (zie figuur 1)

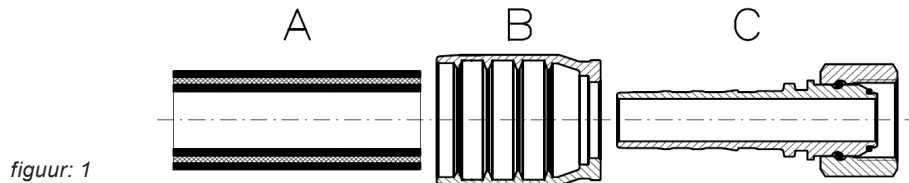

figuur: 1

Stap 2:

Zorg ervoor dat de slang recht wordt afgekort met een afkortmachine op de gewenste lengte

Stap 3:

Indien het nodig is om de slang te schillen, schil de slang (tot op het staal) dan over de lengte welke aangegeven staat op de pers- en schilmatentabel van Oudshoorn – Hydraulics.

Stap 4:

- Schuif de pershuls volledig over de slang
- steek de persslangkoppeling helemaal in de slang
- neem het juiste perskaliber en steek deze door de koppeling in de slang. Het "NO GO" gedeelte moet voor het persen van de koppeling volledig in de slang passen. (zie figuur 2)
- **verwijder het perskaliber.**

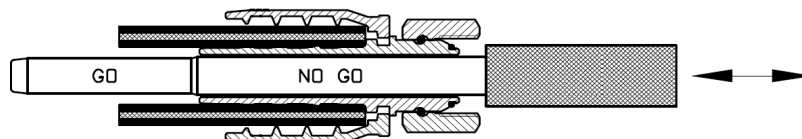

figuur: 2

Stap 5:

Pers de pershuls tot op de juiste persmaat welke op de pers- en schilmatentabel van Oudshoorn Hydraulics is aangegeven.

Stap 6:

Controleer de persmaat door op de buitenzijde van de pershuls de maat te meten met een schuifmaat. (meet altijd in het midden van de pershuls en op de afdruk van de persbek)

De maat welke aan de buitenzijde van de pershuls wordt gemeten moet overeenkomen met de persmaat welke aangegeven staan op de pers- en schilmatentabel van Oudshoorn Hydraulics. Maximale maattolerantie : +0,0/-0,2mm

Stap 7:

Neem het perskaliber en steek deze door de koppeling in de slang.

Stap 8:

Indien het "NO GO" gedeelte van het perskaliber niet in de persslangkoppeling schuift, (zie figuur 3) dan is de persmaat en de inpersing correct.

Stap 9:

Indien het "NO GO" gedeelte van het perskaliber wel in de persslangkoppeling schuift, dan moet de persdiameter verlaagd worden met 0,1mm, zodat de perskaliber wel blijft steken voor het "NO GO" gedeelte in de persslangkoppeling schuift.

Stap 10:

Indien het "GO" gedeelte van het perskaliber niet in de persslangkoppeling schuift, dan moet de persdiameter vergoot worden met 0,1mm, zodat de perskaliber wel blijft steken voor het "NO GO" gedeelte in de persslangkoppeling schuift. (zie figuur 3)

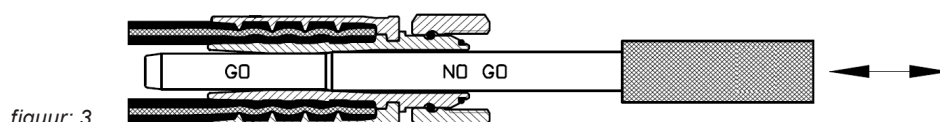

figuur: 3

BSP banjo persslangkoppeling type BAB

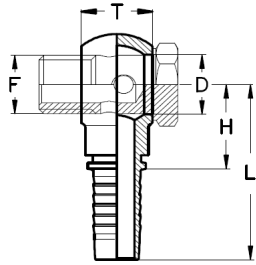

Modellen:

Bestelnummer	slangmaat	F	H	L	D	T	max. werkdruk bar*
C02BAB-03	3/16	1/8	20	45	10,2	10	280
C04BAB-03	3/16	1/4	22,6	47,6	13,3	14	280
C02BAB-04	1/4	1/8	23	51	10,2	10	280
C04BAB-04	1/4	1/4	23	51	13,3	14	280
C06BAB-04	1/4	3/8	26,5	54,5	16,8	17,5	280
C04BAB-05	5/16	1/4	24	52	13,3	14	280
C06BAB-05	5/16	3/8	26,5	54,5	16,8	17,5	280
C04BAB-06	3/8	1/4	24	54,5	13,3	14	280
C06BAB-06	3/8	3/8	24	54,5	16,8	17,5	280
C08BAB-06	3/8	1/2	32	62,5	21	23	250
C06BAB-08	1/2	3/8	26,5	59,5	16,8	17,5	280
C08BAB-08	1/2	1/2	28,5	61,5	21	23	250
C12BAB-08	1/2	3/4	39	72	26,5	29,5	210
C12BAB-10	5/8	3/4	27,2	63	21	23	210
C12BAB-12	3/4	3/4	37,5	78	26,5	29,5	210
C16BAB-12	3/4	1	39,5	90,5	33,5	37,5	165
C16BAB-16	1	1	49	100	33,5	37,5	165

Metrische banjo persslangkoppeling type BAM

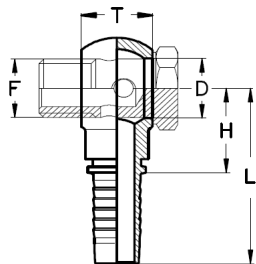

Modellen:

Bestelnummer	slangmaat	F	H	L	D	T	max. werkdruk bar*
C10BAM-04-HOL	1/4	M10x1	23	51	10,2	10	200
C12BAM-04	1/4	M12x1,5	23	51	12,1	12	200
C14BAM-04	1/4	M14x1,5	23	51	14,2	14	200
C16BAM-04	1/4	M16x1,5	26,5	54,5	16,2	17,5	200
C18BAM-04	1/4	M18x1,5	28,5	56,5	18,2	20,5	200
C14BAM-05	5/16	M14x1,5	24	52	14,2	14	200
C16BAM-05	5/16	M16x1,5	25,5	54,5	16,2	17,5	200
C18BAM-05	5/16	M18x1,5	28,5	56,5	18,2	20,5	200
C14BAM-06	3/8	M14x1,5	24	54,5	14,2	14	200
C16BAM-06	3/8	M16x1,5	24	54,5	16,2	17,5	200
C18BAM-06	3/8	M18x1,5	27	57,5	18,2	20,5	200
C22BAM-06	3/8	M22x1,5	32	62,5	22,2	22,5	200
C18BAM-08	1/2	M18x1,5	28,1	61,1	18,2	20,5	200
C22BAM-08	1/2	M22x1,5	28,5	61,5	22,2	22,5	200
C22BAM-10	5/8	M22x1,5	27,2	63	22,2	22,5	200
C30BAM-12	3/4	M30x1,5	41,5	82	30,2	36	200
C30BAM-16	1	M30x1,5	43	94	30,2	36	200

* Attentie: let ook op de maximale werkdruk van de slang.

BSP Wartelkoppeling met 60° conus type BF

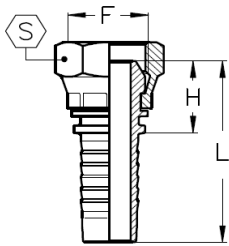

Modellen:

Bestelnummer	slangmaat	F	H	L	S	max. werkdruk bar*
C02BF-03	3/16	1/8	16	41	14	350
C04BF-03	3/16	1/4	19	44	19	415
C02BF-04	1/4	1/8	17	45	14	350
C04BF-04	1/4	1/4	19	47	19	450
C06BF-04	1/4	3/8	22	50	22	450
C08BF-04	1/4	1/2	23	51	27	450
C04BF-05	5/16	1/4	19	47	19	350
C06BF-05	5/16	3/8	22	50	22	350
C08BF-05	5/16	1/2	23	51	27	350
C04BF-06	3/8	1/4	19	49	19	445
C06BF-06	3/8	3/8	21	51	22	445
C08BF-06	3/8	1/2	23	54	27	415
C06BF-08	1/2	3/8	22	56	22	415
C08BF-08	1/2	1/2	23	56	27	415
C10BF-08	1/2	5/8	23	59	27	350
C12BF-08	1/2	3/4	27	60	32	350
C08BF-10	5/8	1/2	23	59	27	350
C10BF-10	5/8	5/8	23	59	30	350
C12BF-10	5/8	3/4	27	63	32	350
C10BF-12	3/4	5/8	24	64	30	350
C12BF-12	3/4	3/4	27	67	32	350
C16BF-12	3/4	1	30	70	41	280
C16BF-16	1	1	30	81	41	280
C20BF-16	1	1 1/4	35	86	50	250
C20BF-20	1 1/4	1 1/4	34	92	50	210
C24BF-20	1 1/4	1 1/2	36	93	55	210
C24BF-24	1 1/2	1 1/2	34	99	55	185
C32BF-24	1 1/2	2	39	103	70	185
C32BF-32	2	2	37	107	70	175

BSP 45° Wartelkoppeling met 60° conus type B45

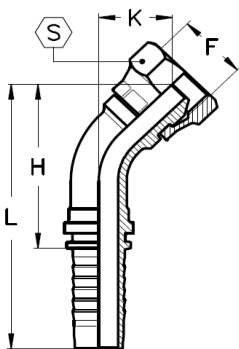

Modellen:

Bestelnummer	slangmaat	F	H	L	K	S	max. werkdruk bar*
C02B45-03	3/16	1/8	33	58	14	14	350
C04B45-03	3/16	1/4	35	60	16	19	415
C02B45-04	1/4	1/8	36	64	16	14	350
C04B45-04	1/4	1/4	37	65	16	19	450
C06B45-04	1/4	3/8	40	68	19	22	450
C08B45-04	1/4	1/2	42	70	21	27	450
C04B45-05	5/16	1/4	39	67	18	19	350

* Attentie: let ook op de maximale werkdruk van de slang.

BSP 45° Wartelkoppeling met 60° conus type B45

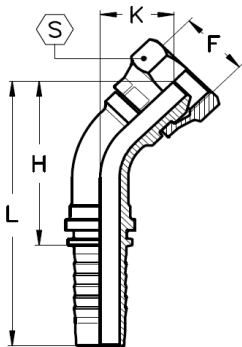

Modellen:

Bestelnummer	slangmaat	F	H	L	K	S	max. werkdruk bar*
C06B45-05	5/16	3/8	41	69	19	22	350
C08B45-05	5/16	1/2	43	71	21	27	350
C04B45-06	3/8	1/4	41	72	18	19	445
C06B45-06	3/8	3/8	42	73	19	22	445
C06B45-08	1/2	3/8	49	82	22	22	415
C08B45-08	1/2	1/2	49	82	22	27	415
C10B45-08	1/2	5/8	48	82	22	30	350
C12B45-08	1/2	3/4	53	86	26	32	350
C08B45-10	5/8	1/2	54	90	24	30	350
C10B45-10	5/8	5/8	54	90	24	30	350
C12B45-10	5/8	3/4	57	93	26	32	350
C12B45-12	3/4	3/4	66	106	28	32	350
C16B45-12	3/4	1	68	108	30	41	280
C16B45-16	1	1	84	135	36	41	280
C20B45-16	1	1 1/4	85	136	37	50	250
C20B45-20	1 1/4	1 1/4	100	157	43	50	210
C24B45-20	1 1/4	1 1/2	100	157	43	55	210
C24B45-24	1 1/2	1 1/2	116	180	49	55	185
C32B45-24	1 1/2	2	116	180	49	70	185
C32B45-32	2	2	157	227	69	70	175

BSP 90° Wartelkoppeling met 60° conus type B90

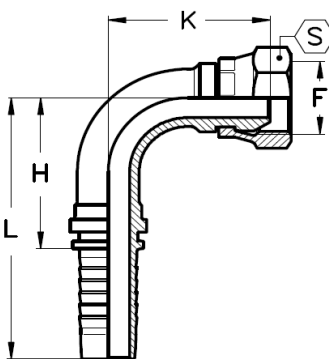

Modellen:

Bestelnummer	slangmaat	F	H	L	K	S	max. werkdruk bar*
C02B90-03	3/16	1/8	21	46	23	14	350
C04B90-03	3/16	1/4	21	46	26	19	415
C02B90-04	1/4	1/8	26	54	28	14	350
C04B90-04	1/4	1/4	26	54	28	19	450
C06B90-04	1/4	3/8	26	54	32	22	450
C08B90-04	1/4	1/2	26	54	36	27	450
C04B90-05	5/16	1/4	28	56	31	19	350
C06B90-05	5/16	3/8	28	56	34	22	350
C08B90-05	5/16	1/2	28	56	37	27	350
C04B90-06	3/8	1/4	31	61	34	19	445
C06B90-06	3/8	3/8	31	61	35	22	445
C08B90-06	3/8	1/2	31	61	38	27	415
C06B90-08	1/2	3/8	37	70	42	22	415
C08B90-08	1/2	1/2	37	70	42	27	415
C10B90-08	1/2	5/8	37	70	43	30	350
C12B90-08	1/2	3/4	37	70	42	27	350

* Attentie: let ook op de maximale werkdruk van de slang.

BSP 90° Wartelkoppeling met 60° conus type B90

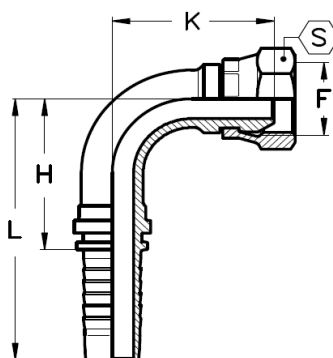

Modellen:

Bestelnummer	slangmaat	F	H	L	K	S	max. werkdruk bar*
C08B90-10	5/8	1/2	37	70	43	30	350
C10B90-10	5/8	5/8	45	80	46	30	350
C12B90-10	5/8	3/4	45	80	50	32	350
C12B90-12	3/4	3/4	54	95	56	32	350
C16B90-12	3/4	1	54	95	59	41	280
C16B90-16	1	1	70	121	72	41	280
C20B90-16	1	1 1/4	70	121	73	50	250
C20B90-20	1 1/4	1 1/4	84	142	87	50	210
C24B90-20	1 1/4	1 1/2	84	142	87	55	210
C24B90-24	1 1/2	1 1/2	100	165	100	55	185
C32B90-24	1 1/2	2	100	165	100	70	185
C32B90-32	2	2	134	204	141	70	175

BSP 90° Compacte wartelkoppeling met 60° conus type B90K

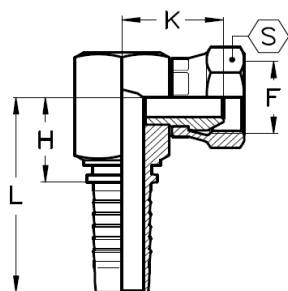

Modellen:

Bestelnummer	slangmaat	F	H	L	K	S	max. werkdruk bar*
C04B90K-04	1/4	1/4	18	46	23	19	450
C06B90K-06	3/8	3/8	21	52	26	22	445
C08B90K-08	1/2	1/2	24	57	28	27	415
C12B90K-12	3/4	3/4	31	72	35	32	350
C16B90K-16	1	1	38	89	41	41	280

BSP wartelkoppeling vlakke afdichting type BFF

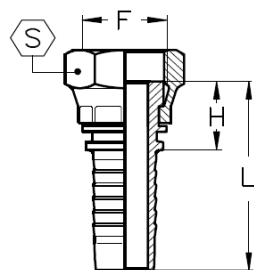

Modellen:

Bestelnummer	slangmaat	F	H	L	S	max. werkdruk bar*
C04BFF-04	1/4	1/4	15	43	19	450
C06BFF-04	1/4	3/8	18	46	22	450
C06BFF-05	5/16	3/8	18	46	22	350
C06BFF-06	3/8	3/8	17	47	22	445
C08BFF-06	3/8	1/2	19	49	27	415
C08BFF-08	1/2	1/2	19	52	27	415
C12BFF-08	1/2	3/4	23	56	32	350
C12BFF-10	5/8	3/4	23	59	32	350
C12BFF-12	3/4	3/4	22	63	32	350
C16BFF-12	3/4	1	25	65	41	280
C16BFF-16	1	1	25	76	41	280
C20BFF-20	1 1/4	1 1/4	28	90	50	210

* Attentie: let ook op de maximale werkdruk van de slang.

BSP wartelkoppeling negatieve 60° conus Japans Toyota type BJF

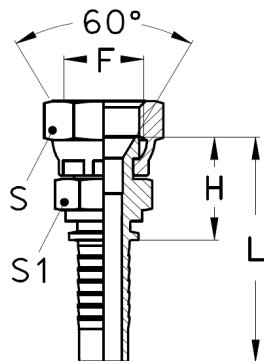

Modellen:

Bestelnummer	slangmaat	F	H	L	S	S1	max. werkdruk bar*
C04BJF-04	1/4	1/4	21,5	49,5	19	17	350
C06BJF-06	3/8	3/8	22,5	53	22	19	350
C08BJF-08	1/2	1/2	26	59	27	22	350
C12BJF-12	3/4	3/4	31	71,5	32	27	280
C16BJF-16	1	1	36	87	41	36	210

BSP koppeling uitwendige draad 60° conus type BM

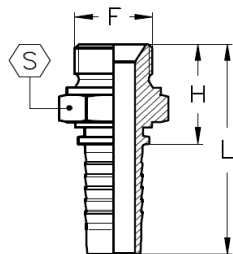

Modellen:

Bestelnummer	slangmaat	F	H	L	S	max. werkdruk bar*
C02BM-03	3/16	1/8	20	45	14	350
C04BM-03	3/16	1/4	24	49	19	415
C02BM-04	1/4	1/8	20	48	14	350
C04BM-04	1/4	1/4	25	53	19	450
C06BM-04	1/4	3/8	27	55	22	450
C08BM-04	1/4	1/2	32	60	27	415
C04BM-05	5/16	1/4	25	53	19	350
C06BM-05	5/16	3/8	27	55	22	350
C08BM-05	5/16	1/2	32	60	27	350
C04BM-06	3/8	1/4	25	55	19	445
C06BM-06	3/8	3/8	27	58	22	445
C08BM-06	3/8	1/2	32	62	27	415
C06BM-08	1/2	3/8	28	61	22	415
C08BM-08	1/2	1/2	33	66	27	415
C10BM-08	1/2	5/8	35	68	30	350
C12BM-08	1/2	3/4	36	69	32	350
C08BM-10	5/8	1/2	33	69	27	350
C10BM-10	5/8	5/8	35	71	30	350
C12BM-10	5/8	3/4	36	72	32	350
C12BM-12	3/4	3/4	37	77	32	350
C16BM-12	3/4	1	42	82	41	280
C16BM-16	1	1	43	94	41	280
C20BM-16	1	1 1/4	46	97	50	250
C20BM-20	1 1/4	1 1/4	47	105	50	210
C24BM-20	1 1/4	1 1/2	50	108	55	210
C24BM-24	1 1/2	1 1/2	50	115	55	185
C32BM-24	1 1/2	2	55	119	70	185
C32BM-32	2	2	56	126	70	175

* Attentie: let ook op de maximale werkdruk van de slang.

BSP koppeling uitwendige draad vlakke afdichting type BMF

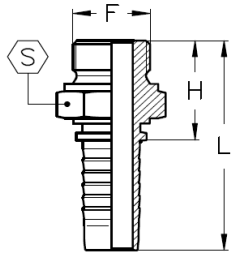

Modellen:

Bestelnummer	slangmaat	F	H	L	S	max. werkdruk bar*
C04BMF-04	1/4	1/4	25	53	19	450
C06BMF-04	1/4	3/8	27	55	22	450
C06BMF-05	5/16	3/8	27	55	22	350
C06BMF-06	3/8	3/8	27	58	22	445
C08BMF-06	3/8	1/2	32	62	27	415
C08BMF-08	1/2	1/2	33	66	27	415
C12BMF-08	1/2	3/4	36	69	32	350
C12BMF-10	5/8	3/4	36	72	32	350
C12BMF-12	3/4	3/4	37	77	32	350
C16BMF-12	3/4	1	42	82	41	280
C16BMF-16	1	1	43	94	41	280

BSP koppeling conische uitwendige draad type BMT

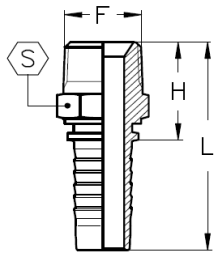

Modellen:

Bestelnummer	slangmaat	F	H	L	S	max. werkdruk bar*
C04BMT-04	1/4	1/4	25	53	15	350
C06BMT-04	1/4	3/8	26	54	19	280
C06BMT-05	5/16	3/8	26	54	19	280
C06BMT-06	3/8	3/8	27	57	19	280
C08BMT-06	3/8	1/2	32	63	22	280
C08BMT-08	1/2	1/2	33	66	22	280
C12BMT-10	5/8	3/4	35	71	27	280
C12BMT-12	3/4	3/4	36	77	27	280
C16BMT-16	1	1	43	94	36	280
C20BMT-20	1 1/4	1 1/4	48	106	46	210
C24BMT-20	1 1/4	1 1/2	49	110	50	185
C24BMT-24	1 1/2	1 1/2	49	114	50	185
C32BMT-32	2	2	57	127	65	175

* Attentie: let ook op de maximale werkdruk van de slang.

Metrische wartelkoppeling 24° conus en o-ring type DF
DIN2353

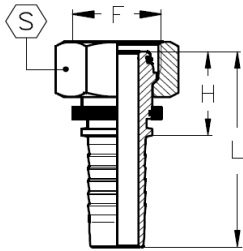

Modellen:

Serie L							
Bestelnummer	slangmaat	leidingmaat	F	H	L	S	max. werkdruk bar*
C12DF-06L-03	3/16	6L	M12x1,5	21	46	14	280
C14DF-08L-03	3/16	8L	M14x1,5	21	46	17	280
C12DF-06L-04	1/4	6L	M12x1,5	23	51	17	280
C14DF-08L-04	1/4	8L	M14x1,5	22	50	17	280
C16DF-10L-04	1/4	10L	M16x1,5	24	52	19	280
C18DF-12L-04	1/4	12L	M18x1,5	25	52	22	280
C14DF-08L-05	5/16	8L	M14x1,5	27	54	19	280
C16DF-10L-05	5/16	10L	M16,1,5	24	52	19	280
C18DF-12L-05	5/16	12L	M18x1,5	24	52	22	280
C16DF-10L-06	3/8	10L	M16x1,5	23	54	19	280
C18DF-12L-06	3/8	12L	M18x1,5	24	54	22	280
C22DF-15L-06	3/8	15L	M22x1,5	24	54	27	280
C22DF-15L-08	1/2	15L	M22x1,5	24	57	27	280
C26DF-18L-08	1/2	18L	M26x1,5	26	59	32	210
C26DF-18L-10	5/8	18L	M26x1,5	27	62	32	210
C30DF-22L-10	5/8	22L	M30x2	28	64	36	210
C30DF-22L-12	3/4	22L	M30x2	31	71	36	210
C36DF-28L-16	1	28L	M36x2	32	83	41	165
C45DF-35L-20	1 1/4	35L	M45x2	36	94	50	125
C52DF-42L-24	1 1/2	42L	M52x2	37	102	60	100
Serie S							
Bestelnummer	slangmaat	leidingmaat	F	H	L	S	max. werkdruk bar*
C14DF-06S-04	1/4	6S	M14x1,5	23	51	17	450
C16DF-08S-04	1/4	8S	M16x1,5	22	50	19	450
C18DF-10S-04	1/4	10S	M18x1,5	24	52	22	450
C18DF-10S-05	5/16	10S	M18x1,5	24	52	22	350
C20DF-12S-05	5/16	12S	M20x1,5	24	52	24	350
C18DF-10S-06	3/8	10S	M18x1,5	25	55	22	445
C20DF-12S-06	3/8	12S	M20x1,5	24	54	24	445
C22DF-14S-06	3/8	14S	M22x1,5	28	58	27	445
C22DF-14S-08	1/2	14S	M22x1,5	28	61	27	415
C24DF-16S-08	1/2	16S	M24x1,5	29	62	30	415
C30DF-20S-10	5/8	20S	M30x2	33	69	36	350
C30DF-20S-12	3/4	20S	M30x2	36	76	36	350
C36DF-25S-12	3/4	25S	M36x2	38	78	46	350
C36DF-25S-16	1	25S	M36x2	40	91	46	280
C42DF-30S-16	1	30S	M42x2	40	91	50	280
C42DF-30S-20	1 1/4	30S	M42x2	41	99	50	210
C52DF-38S-20	1 1/4	38S	M52x2	45	103	60	210
C52DF-38S-24	1 1/2	38S	M52x2	46	110	60	185

* Attentie: let ook op de maximale werkdruk van de slang.

Metrische 45° wartelkoppeling 24° conus en o-ring type D45
DIN2353

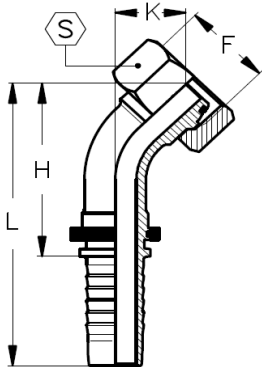

Modellen:

Serie L								
Bestelnummer	slangmaat	leiding maat	F	H	L	K	S	max. werkdruk bar*
C12D45-06L-04	1/4	6L	M12x1,5	35	63	14	17	280
C14D45-08L-04	1/4	8L	M14x1,5	36	64	14	17	280
C16D45-10L-04	1/4	10L	M16x1,5	38	66	16	19	280
C18D45-12L-04	1/4	12L	M18x1,5	39	67	17	22	280
C16D45-10L-05	5/16	10L	M16x1,5	39	67	17	19	280
C18D45-12L-05	5/16	12L	M18x1,5	39	67	18	22	280
C16D45-10L-06	3/8	10L	M16x1,5	39	69	16	19	280
C18D45-12L-06	3/8	12L	M18x1,5	40	71	18	22	280
C22D45-15L-06	3/8	15L	M22x1,5	42	72	19	27	280
C22D45-15L-08	1/2	15L	M22x1,5	46	79	19	27	280
C26D45-18L-08	1/2	18L	M26x1,5	47	80	21	32	210
C26D45-18L-10	5/8	18L	M26x1,5	53	89	22	32	210
C30D45-22L-10	5/8	22L	M30x2	54	90	23	36	210
C30D45-22L-12	3/4	22L	M30x2	62	103	25	36	210
C36D45-28L-16	1	28L	M36x2	80	131	31	41	165
C45D45-35L-20	1 1/4	35L	M45x2	96	154	40	50	100
C52D45-42L-24	1 1/2	42L	M52x2	115	179	48	60	100
Serie S								
Bestelnummer	slangmaat	leiding maat	F	H	L	K	S	max. werkdruk bar*
C14D45-06S-04	1/4	6S	M14x1,5	35	63	14	17	450
C16D45-08S-04	1/4	8S	M16x1,5	36	64	14	19	450
C18D45-10S-04	1/4	10S	M18x1,5	38	66	16	22	450
C18D45-10S-05	5/16	10S	M18x1,5	39	67	17	22	350
C20D45-12S-05	5/16	12S	M20x1,5	39	67	18	24	350
C18D45-10S-06	3/8	10S	M18x1,5	40	70	17	22	445
C20D45-12S-06	3/8	12S	M20x1,5	40	71	18	24	445
C22D45-14S-06	3/8	14S	M22x1,5	42	72	19	27	445
C22D45-14S-08	1/2	14S	M22x1,5	46	79	20	27	415
C24D45-16S-08	1/2	16S	M24x1,5	47	80	21	30	415
C30D45-20S-10	5/8	20S	M30x2	56	92	25	36	350
C30D45-20S-12	3/4	20S	M30x2	64	105	27	36	350
C36D45-25S-12	3/4	25S	M36x2	64	105	28	46	350
C36D45-25S-16	1	25S	M36x2	82	133	34	41	280
C42D45-30S-16	1	30S	M42x2	80	131	31	50	280
C52D45-38S-20	1 1/4	38S	M52x2	94	152	38	60	210
C52D45-38S-24	1 1/2	38S	M52x2	115	180	49	60	185

* Attentie: let ook op de maximale werkdruk van de slang.

Metrische 90° wartelkoppeling 24° conus en o-ring type D90
DIN2353

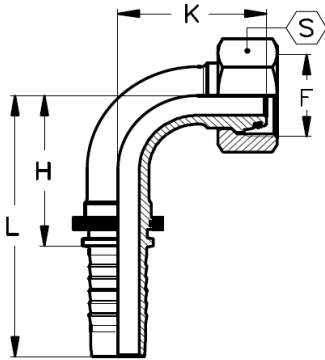

Modellen:

Serie L								
Bestelnummer	slangmaat	leiding maat	F	H	L	K	S	max. werkdruk bar*
C12D90-06L-04	1/4	6L	M12x1,5	26	53	26	17	280
C14D90-08L-04	1/4	8L	M14x1,5	29	57	29	17	280
C16D90-10L-04	1/4	10L	M16x1,5	29	57	30	19	280
C18D90-12L-04	1/4	12L	M18x1,5	29	57	32	22	280
C16D90-10L-05	5/16	10L	M16x1,5	31	59	33	19	280
C18D90-12L-05	5/16	12L	M18x1,5	28	56	32	22	280
C16D90-10L-06	3/8	10L	M16x1,5	31	61	31	19	280
C18D90-12L-06	3/8	12L	M18x1,5	31	61	33	22	280
C22D90-15L-06	3/8	15L	M22x1,5	31	61	35	27	280
C22D90-15L-08	1/2	15L	M22x1,5	37	70	38	27	280
C26D90-18L-08	1/2	18L	M26x1,5	37	70	40	32	210
C26D90-18L-10	5/8	18L	M26x1,5	44	80	45	32	210
C30D90-22L-10	5/8	22L	M30x2	44	80	47	36	210
C30D90-22L-12	3/4	22L	M30x2	54	94	52	36	210
C36D90-28L-16	1	28L	M36x2	70	121	66	41	165
C45D90-35L-20	1 1/4	35L	M45x2	84	141	83	50	100
C52D90-42L-24	1 1/2	42L	M52x2	100	164	100	60	100
Serie S								
Bestelnummer	slangmaat	leiding maat	F	H	L	K	S	max. werkdruk bar*
C14D90-06S-04	1/4	6S	M14x1,5	25	53	26	17	450
C16D90-08S-04	1/4	8S	M16x1,5	29	57	29	19	450
C18D90-10S-04	1/4	10S	M18x1,5	29	57	30	22	450
C18D90-10S-05	5/16	10S	M18x1,5	31	59	33	22	350
C20D90-12S-05	5/16	12S	M20x1,5	28	56	32	24	350
C18D90-10S-06	3/8	10S	M18x1,5	30	61	33	22	445
C20D90-12S-06	3/8	12S	M20x1,5	31	61	33	24	445
C22D90-14S-06	3/8	14S	M22x1,5	34	64	37	27	445
C22D90-14S-08	1/2	14S	M22x1,5	39	71	41	27	415
C24D90-16S-08	1/2	16S	M24x1,5	39	71	42	30	415
C30D90-20S-10	5/8	20S	M30x2	44	80	49	36	350
C30D90-20S-12	3/4	20S	M30x2	54	94	55	36	350
C36D90-25S-12	3/4	25S	M36x2	54	94	57	46	350
C36D90-25S-16	1	25S	M36x2	70	121	70	46	280
C42D90-30S-16	1	30S	M42x2	70	121	66	50	280
C52D90-38S-20	1 1/4	38S	M52x2	84	141	80	60	210
C52D90-38S-24	1 1/2	38S	M52x2	100	164	101	60	185

* Attentie: let ook op de maximale werkdruk van de slang.

Metrische wartelkoppeling 60° conus type DF60°

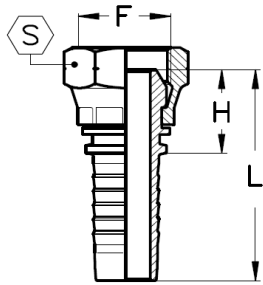

Modellen:

Bestelnummer	slangmaat	F	H	L	S	max. werkdruk bar*
C10DF-03	3/16	M10x1	16	41	14	280
C10DF-04	1/4	M10x1	16	41	15	280
C12DF-04	1/4	M12x1,5	16,5	44,5	15	280
C14DF-04	1/4	M14x1,5	18,5	46,5	17	280
C16DF-04	1/4	M16x1,5	18,5	46,5	19	280
C18DF-04	1/4	M18x1,5	21,5	49,5	22	280
C14DF-05	5/16	M14x1,5	19	47	17	280
C16DF-05	5/16	M16x1,5	18	46	19	280
C18DF-05	5/16	M18x1,5	21,5	49,5	22	280
C14DF-06	3/8	M14x1,5	19,5	50	17	280
C16DF-06	3/8	M16x1,5	18,5	49	19	280
C18DF-06	3/8	M18x1,5	20,5	51	22	280
C20DF-06	3/8	M20x1,5	20,5	51	24	280
C22DF-06	3/8	M22x1,5	23	53,5	27	280
C18DF-08	1/2	M18x1,5	22,5	55,5	22	280
C20DF-08	1/2	M20x1,5	21,5	54,5	24	280
C22DF-08	1/2	M22x1,5	23	56	27	280
C26DF-08	1/2	M26x1,5	27	60	32	280
C26DF-10	5/8	M26x1,5	27	63	32	280
C26DF-12	3/4	M26x1,5	26,5	67	32	280
C30DF-12	3/4	M30x1,5	27	67,5	36	210
C38DF-16	1	M38x1,5	31	82	46	165
C45DF-20	1 1/4	M45x1,5	32	89,5	50	125

Metrische wartelkoppeling 60° conus type D90-60°

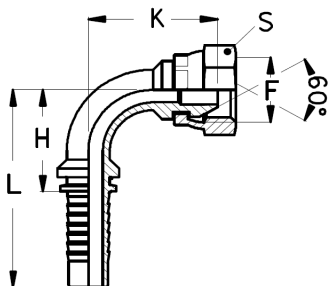

Modellen:

Bestelnummer	slangmaat	F	H	L	K	S	max. werkdruk bar*
C14D90-04	1/4	M14x1,5	24	52	28	17	280
C16D90-04	1/4	M16x1,5	24	52	31	22	280
C18D90-04	1/4	M18x1,5	24	52	31	22	280
C16D90-05	5/16	M16x1,5	31	59	33,5	22	280
C18D90-05	5/16	M18x1,5	31	59	33,5	22	280
C16D90-06	3/8	M16x1,5	34	64	40,5	22	280
C18D90-06	3/8	M18x1,5	34	64	40,5	22	280
C20D90-06	3/8	M20x1,5	34	64	40,5	27	280
C22D90-06	3/8	M22x1,5	34	64	40,5	27	280
C20D90-08	1/2	M20x1,5	41	74	44	27	280
C22D90-08	1/2	M22x1,5	41	74	44	27	280
C26D90-10	5/8	M26x1,5	49	85	54,5	32	280
C26D90-12	3/4	M26x1,5	58	99	60,5	32	280
C30D90-12	3/4	M30x1,5	58	99	65	36	210

* Attentie: let ook op de maximale werkdruk van de slang.

Metrische koppeling uitwendige draad met 60° conus type DM60°

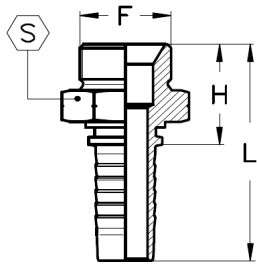

Modellen:

Bestelnummer	slangmaat	F	H	L	S	max. werkdruk bar*
C10DM-03	3/16	M10x1	18,5	43,5	14	280
C12DM-03	3/16	M12x1,5	23,5	48,5	17	280
C10DM-04	1/4	M10x1	19	47	14	280
C12DM-04	1/4	M12x1,5	24	52	17	280
C14DM-04	1/4	M14x1,5	24	52	19	280
C16DM-04	1/4	M16x1,5	25	53	22	280
C18DM-04	1/4	M18x1,8	26	54	24	280
C14DM-05	5/16	M14x1,5	24	52	19	280
C16DM-05	5/16	M16x1,5	25	53	22	280
C18DM-05	5/16	M18x1,5	26	54	24	280
C14DM-06	3/8	M14x1,5	24	54,5	19	280
C16DM-06	3/8	M16x1,5	25	55,5	22	280
C18DM-06	3/8	M18x1,5	26	56,5	24	280
C18DM-08	1/2	M18x1,5	27	60	24	280
C22DM-08	1/2	M22x1,5	30	63	27	280
C26DM-10	5/8	M26x1,5	33	69	32	280
C26DM-12	3/4	M26x1,5	34	74,5	32	280
C30DM-12	3/4	M30x1,5	35	75,5	36	210
C38DM-16	1	M38x1,5	38,5	89,5	46	165
C45DM-20	1 1/4	M45x1,5	41,5	99	55	125

Metrische koppeling uitwendige draad Franse GAZ serie type GE

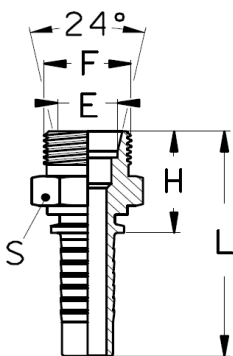

Modellen:

Bestelnummer	slangmaat	F	leiding- maat	H	L	S	max. werkdruk bar*
C20GE-13-05	5/16	M20x1,5	13,25	25	53	22	350
C30GE-21-10	5/8	M30x1,5	21,25	30	66	30	280
C30GE-21-12	3/4	M30x1,5	21,25	31	71,5	30	280
C36GE-27-12	3/4	M36x1,5	26,75	33	73,5	36	210
C45GE-33-16	1	M45x1,5	33,5	38,5	89,5	46	210
C45GE-33-20	1 1/4	M45x1,5	33,5	39,5	97	46	125

* Attentie: let ook op de maximale werkdruk van de slang.

Metrische wartelkoppeling Franse GAZ serie type GF

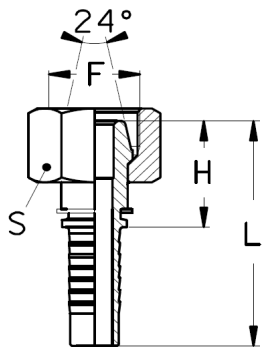

Modellen:

Bestelnummer	slangmaat	F	leiding- maat	H	L	S	max. werkdruk bar*
C20GF-13-05	5/16	M20x1,5	13,25	22	50	24	350
C20GF-13-06	3/8	M20x1,5	13,25	21,5	52	24	330
C24GF-17-08	1/2	M24x1,5	16,75	25,5	58,5	30	280
C30GF-21-10	5/8	M30x1,5	21,25	26,5	62	36	280
C30GF-21-12	3/4	M30x1,5	21,25	27,5	68	36	280
C36GF-27-12	3/4	M36x1,5	26,75	29	68,5	41	210
C45GF-33-16	1	M45x1,5	33,5	31,5	82,5	50	210

Metrische 90° wartelkoppeling Franse GAZ serie type G90

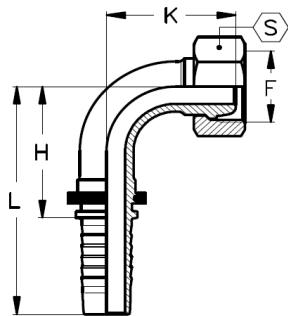

Modellen:

Bestelnummer	slangmaat	F	leiding- maat	H	L	K	S	max. werkdruk bar*
C20G90-13-05	5/16	M20x1,5	13,25	28	56	30	24	350
C20G90-13-06	3/8	M20x1,5	13,25	30,5	61	31,5	24	330
C24G90-17-08	1/2	M24x1,5	16,75	37	70	40	30	280
C36G90-27-12	3/4	M36x1,5	26,75	53,5	94	52	41	210

Pijpkoppeling voor snijring montage Franse GAZ serie type GSE

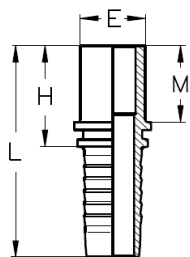

Modellen:

Bestelnummer	slangmaat	leiding- maat E	H	L	M	max. werkdruk bar*
C13GSE-05	5/16	13,25	30,5	58,5	24	350
C13GSE-06	3/8	13,25	30,5	61	24	330
C17GSE-08	1/2	16,75	33,5	66,5	26	280
C21GSE-10	5/8	21,25	36	71,5	28	280
C27GSE-12	3/4	26,75	40,5	81	30	210
C33GSE-16	1	33,5	44	95	32	210

* Attentie: let ook op de maximale werkdruk van de slang.

JIC wartelkoppeling met 37° conus type JF

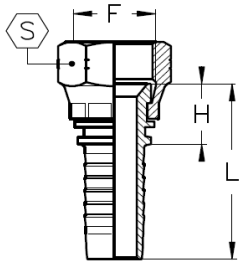

Modellen:

Bestelnummer	slangmaat	F UNF	H	L	S	max. werkdruk bar*
C07JF-03	3/16	7/16	13,5	38,5	14	415
C07JF-04	1/4	7/16	14	42	14	400
C08JF-04	1/4	1/2	14,5	42,5	17	400
C09JF-04	1/4	9/16	16,5	44,5	19	350
C08JF-05	5/16	1/2	14,5	42,5	17	350
C09JF-05	5/16	9/16	15,5	43,5	19	350
C12JF-05	5/16	3/4	17,5	45,5	22	350
C09JF-06	3/8	9/16	15,5	46	19	350
C12JF-06	3/8	3/4	17,5	48	22	350
C14JF-06	3/8	7/8	18,5	48	27	350
C12JF-08	1/2	3/4	17,5	50,5	22	350
C14JF-08	1/2	7/8	18,5	51,5	27	350
C17JF-08	1/2	1 1/16	21,8	54,8	32	350
C14JF-10	5/8	7/8	18,7	54,5	27	350
C17JF-10	5/8	1 1/16	22	57,8	32	350
C14JF-12	3/4	7/8	19,5	60	27	350
C17JF-12	3/4	1 1/16	21,3	61,8	32	350
C19JF-12	3/4	1 3/16	25	65,5	36	280
C21JF-12	3/4	1 5/16	25,5	66	38	210
C17JF-16	1	1 1/16	22,8	73,8	32	280
C21JF-16	1	1 5/16	25,5	76,5	41	280
C26JF-16	1	1 5/8	28,5	79,5	50	210
C26JF-20	1 1/4	1 5/8	27,8	85,5	50	210
C30JF-20	1 1/4	1 7/8	31,3	89	55	140
C30JF-24	1 1/2	1 7/8	31,3	89	60	185
C40JF-32	2	2 1/2	34	104	70	105

* Attentie: let ook op de maximale werkdruk van de slang.

JIC 45° wartelkoppeling met 37° conus type J45

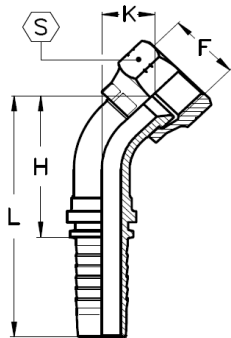

Modellen:

Bestelnummer	slangmaat	F UNF	H	L	K	S	max. werkdruk bar*
C07J45-04	1/4	7/16	31	59	10	14	400
C08J45-04	1/4	1/2	32	60	11	17	400
C09J45-04	1/4	9/16	33	61	12	19	350
C09J45-05	5/16	9/16	34	62	12	19	350
C09J45-06	3/8	9/16	35,5	66	12	19	350
C12J45-06	3/8	3/4	37,5	68	14	22	350
C14J45-06	3/8	7/8	39,5	70	16	27	350
C12J45-08	1/2	3/4	41	37	14,5	22	350
C14J45-08	1/2	7/8	43	76	16	27	350
C14J45-10	5/8	7/8	47	83	16	27	350
C17J45-10	5/8	1 1/16	50	86	19	32	350
C17J45-12	3/4	1 1/16	59	99	22	32	350
C19J45-12	3/4	1 3/16	59	100	22	36	280
C21J45-12	3/4	1 5/16	61	101	24	41	280
C21J45-16	1	1 5/16	72	123	24	38	210
C26J45-16	1	1 5/8	76	127	28	50	210
C26J45-20	1 1/4	1 5/8	95	153	38	50	210
C30J45-20	1 1/4	1 7/8	88	144	32	60	185
C30J45-24	1 1/2	1 7/8	113	178	46	60	185

JIC 90° wartelkoppeling met 37° conus type J90

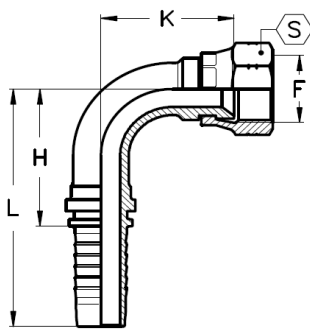

Modellen:

Bestelnummer	slangmaat	F UNF	H	L	K	S	max. werkdruk bar*
C07J90-04	1/4	7/16	25,5	53,5	26	14	415
C08J90-04	1/4	1/2	25,5	53,5	26	17	400
C09J90-04	1/4	9/16	25,5	53,5	27	19	350
C08J90-05	5/16	1/2	28	56	29	17	350
C09J90-05	5/16	9/16	28	56	29	19	350
C12J90-05	5/16	3/4	29	59	32	24	350
C09J90-06	3/8	9/16	31	59	34	19	250
C12J90-06	3/8	3/4	31	61,5	33	22	350
C14J90-06	3/8	7/8	34	64	39	27	200
C12J90-08	1/2	3/4	37	70	39	22	350
C14J90-08	1/2	7/8	37	70	40	27	350
C17J90-08	1/2	1 1/16	41	74	48	32	200
C14J90-10	5/8	7/8	45	81	45	27	350
C17J90-10	5/8	1 1/16	45	81	47	32	350
C14J90-12	3/4	7/8	55	95	54	27	350
C17J90-12	3/4	1 1/16	55	95	53	32	350

* Attentie: let ook op de maximale werkdruk van de slang.

JIC 90° wartelkoppeling met 37° conus type J90

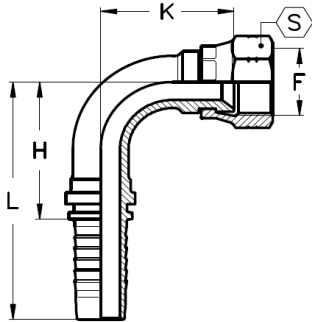

Modellen:

Bestelnummer	slangmaat	F UNF	H	L	K	S	max. werkdruk bar*
C19J90-12	3/4	1 3/16	55	95	54	36	280
C21J90-12	3/4	1 5/16	55	95	56	38	210
C17J90-16	1	1 1/16	71	122	71	32	280
C21J90-16	1	1 5/16	71	122	70	38	210
C26J90-16	1	1 5/8	71	122	70	50	210
C26J90-20	1 1/4	1 5/8	86	143	82	50	210
C30J90-20	1 1/4	1 7/8	86	143	82	55	140
C30J90-24	1 1/2	1 7/8	102	167	96	55	140

JIC koppeling met uitwendige draad 37° conus type JM

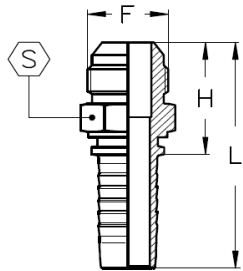

Modellen:

Bestelnummer	slangmaat	F UNF	H	L	S	max. werkdruk bar*
C07JM-04	1/4	7/16	25,5	53,5	12	400
C08JM-04	1/4	1/2	25,5	53,5	14	400
C09JM-04	1/4	9/16	26,6	54,6	15	350
C08JM-05	5/16	1/2	25,5	53,5	14	350
C09JM-05	5/16	9/16	26,6	54,6	15	350
C12JM-05	5/16	3/4	29,7	57,5	19	350
C09JM-06	3/8	9/16	26,6	57,1	15	350
C12JM-06	3/8	3/4	29,7	60,2	19	350
C14JM-06	3/8	7/8	34,3	64,8	24	350
C12JM-08	1/2	3/4	30,7	63,7	19	350
C14JM-08	1/2	7/8	35,3	68,3	24	350
C17JM-08	1/2	1 1/16	38,9	71,9	27	350
C14JM-10	5/8	7/8	35,5	71,3	24	350
C17JM-10	5/8	1 1/16	39,1	74,9	27	350
C17JM-12	3/4	1 1/16	39,9	80,4	27	350
C19JM-12	3/4	1 3/16	41,6	82,1	32	280
C21JM-12	3/4	1 5/16	42,1	82,6	34	280
C17JM-16	1	1 1/16	41,9	92,9	32	280
C21JM-16	1	1 5/16	43,6	94,6	34	280
C26JM-16	1	1 5/8	46,8	97,8	42	280
C26JM-20	1 1/4	1 5/8	47,6	105,3	42	210
C30JM-20	1 1/4	1 7/8	52,8	110,5	50	185
C30JM-24	1 1/2	1 7/8	53	117,5	50	185
C40JM-32	2	2 1/2	63,4	133,4	65	175

* Attentie: let ook op de maximale werkdruk van de slang.

SAE koppeling uitwendige draad met 45° conus type JM

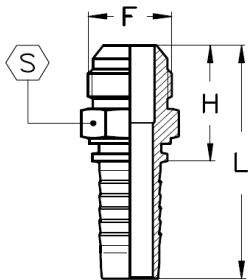

Modellen:

Bestelnummer	slangmaat	F SAE	H	L	S	max. werkdruk bar*
C10JM-05	5/16	5/8	28.2	56.2	16	400
C10JM-06	3/8	5/8	28.2	58,7	16	350

SAE wartelkoppeling met 45° conus type JF

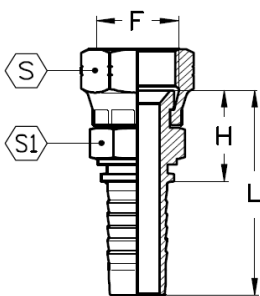

Modellen:

Bestelnummer	slangmaat	F SAE	H	L	S	S1	max. werkdruk bar*
C10JF-05	5/16	5/8	23,5	51,5	22	16	400
C10JF-06	3/8	5/8	23,5	54	22	16	350

SAE 45° wartelkoppeling met 45° conus type J45

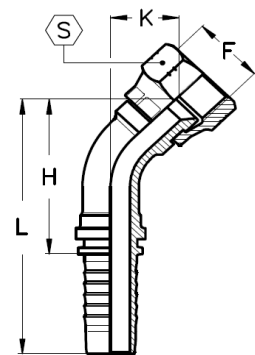

Modellen:

Bestelnummer	slangmaat	F SAE	H	L	K	S	max. werkdruk bar*
C10J45-05	5/16	5/8	38	66	16	22	400
C10J45-06	3/8	5/8	39	69,5	16	22	350

SAE 90° wartelkoppeling met 45° conus type J90

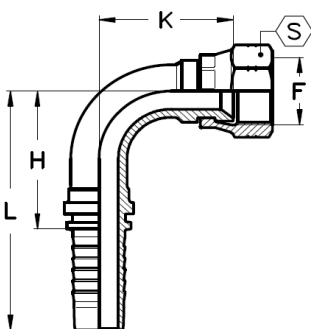

Modellen:

Bestelnummer	slangmaat	F SAE	H	L	K	S	max. werkdruk bar*
C10J90-05	5/16	5/8	28	56	29	22	400
C10J90-06	3/8	5/8	31	61	31	22	350

* Attentie: let ook op de maximale werkdruk van de slang.

Metrische koppeling uitwendige draad 24° conus type ME
DIN2353

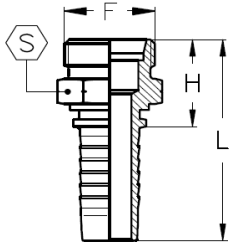

Modellen:

Serie L							
Bestelnummer	slangmaat	leiding maat	F	H	L	S	max. werkdruk bar*
C12ME-06L-03	3/16	6L	M12X1,5	21	46	12	280
C12ME-06L-04	1/4	6L	M12X1,5	21	49	12	280
C14ME-08L-04	1/4	8L	M14X1,5	21	49	14	280
C16ME-10L-04	1/4	10L	M16X1,5	23	51	17	280
C18ME-12L-04	1/4	12L	M18X1,5	23	51	19	280
C16ME-10L-05	5/16	10L	M16X1,5	23	51	17	280
C18ME-12L-05	5/16	12L	M18X1,5	23	51	19	280
C16ME-10L-06	3/8	10L	M16X1,5	23	53	17	280
C18ME-12L-06	3/8	12L	M18X1,5	23	53	19	280
C22ME-15L-06	3/8	15L	M22X1,5	25	56	22	280
C22ME-15L-08	1/2	15L	M22X1,5	26	59	22	280
C26ME-18L-08	1/2	18L	M26X1,5	28	61	27	210
C26ME-18L-10	5/8	18L	M26X1,5	28	64	27	210
C30ME-22L-10	5/8	22L	M30X2	30	66	30	210
C26ME-18L-12	3/4	18L	M26X1,5	29	70	27	210
C30ME-22L-12	3/4	22L	M30X2	31	72	30	210
C36ME-28L-16	1	28L	M36X2	35	86	36	165
C45ME-35L-20	1 1/4	35L	M45X2	40	97	46	100
C52ME-42L-24	1 1/2	42L	M52X2	42	106	55	100
Serie S							
Bestelnummer	slangmaat	leiding maat	F	H	L	S	max. werkdruk bar*
C14ME-06S-04	1/4	6S	M14X1,5	23	51	14	450
C16ME-08S-04	1/4	8S	M16X1,5	23	51	17	450
C18ME-10S-04	1/4	10S	M18X1,5	24	52	19	450
C18ME-10S-05	5/16	10S	M18X1,5	24	52	19	350
C20ME-12S-05	5/16	12S	M20X1,5	25	53	22	350
C18ME-10S-06	3/8	10S	M18X1,5	24	55	19	445
C20ME-12S-06	3/8	12S	M20X1,5	25	56	22	445
C22ME-14S-06	3/8	14S	M22X1,5	27	58	22	445
C22ME-14S-08	1/2	14S	M22X1,5	28	61	22	415
C24ME-16S-08	1/2	16S	M24X1,5	29	62	24	415
C30ME-20S-10	5/8	20S	M30X2	32	68	30	350
C30ME-20S-12	3/4	20S	M30X2	33	74	30	350
C36ME-25S-12	3/4	25S	M36X2	37	78	36	350
C36ME-25S-16	1	25S	M36X2	39	90	36	280
C42ME-30S-16	1	30S	M42X2	43	94	46	280
C42ME-30S-20	1 1/4	30S	M42X2	44	101	46	210
C52ME-38S-20	1 1/4	38S	M52X2	48	105	55	210
C52ME-38S-24	1 1/2	38S	M52X2	48	112	55	185

* Attentie: let ook op de maximale werkdruk van de slang.

Metrische wartelkoppeling "Komatsu" met 60° conus type MJF

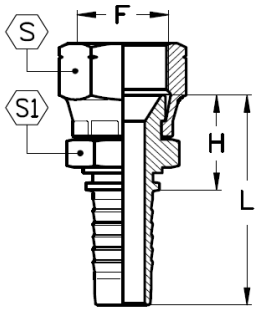

Modellen:

Bestelnummer	slangmaat	F	H	L	S	S1	max. werkdruk bar*
C14MJF-04	1/4	M14X1,5	21,5	49,5	19	17	350
C16MJF-05	5/16	M16X1,5	22	50	22	17	350
C14MJF-06	3/8	M14X1,5	21,5	52	19	17	350
C18MJF-06	3/8	M18X1,5	22,5	53	24	19	350
C22MJF-08	1/2	M22X1,5	26	59	27	22	350
C24MJF-08	1/2	M24X1,5	30	63	32	27	350
C24MJF-10	5/8	M24X1,5	60	66	32	27	280
C30MJF-12	3/4	M30X1,5	33,5	74	36	32	280
C33MJF-16	1	M33X1,5	36	87	41	36	210
C42MJF-24	1 1/2	M42X1,5	42,5	107	50	46	105

NPT koppeling uitwendige draad type NM

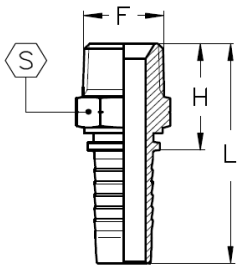

Modellen:

Bestelnummer	slangmaat	F NPT	H	L	S	max. werkdruk bar*
C02NM-03	3/16	1/8	20,5	45,5	12	350
C04NM-03	3/16	1/4	26,5	51,5	14	350
C02NM-04	1/4	1/8	21	49	12	350
C04NM-04	1/4	1/4	27	55	14	350
C06NM-04	1/4	3/8	28,5	56,5	19	280
C04NM-05	5/16	1/4	27	55	14	350
C06NM-05	5/16	3/8	28,5	56,5	19	280
C04NM-06	3/8	1/4	27,5	58	16	350
C06NM-06	3/8	3/8	28,5	59	19	280
C08NM-06	3/8	1/2	34	64,5	22	280
C06NM-08	1/2	3/8	30,5	63,5	22	280
C08NM-08	1/2	1/2	35	68	22	280
C12NM-08	1/2	3/4	37	70	27	280
C08NM-10	5/8	1/2	36	72	25	280
C12NM-10	5/8	3/4	37	73	27	280
C08NM-12	3/4	1/2	37,5	78	27	280
C12NM-12	3/4	3/4	38	78,5	27	280
C16NM-12	3/4	1	45,5	86	35	280
C16NM-16	1	1	47	98	35	280
C20NM-16	1	1 1/4	51	102,1	46	210
C20NM-20	1 1/4	1 1/4	52	109,6	46	210
C24NM-24	1 1/2	1 1/2	55	119,5	50	185
C32NM-32	2	2	64	134	65	175

* Attentie: let ook op de maximale werkdruk van de slang.

ORFS wartelkoppeling vlakke afdichting type ORFS

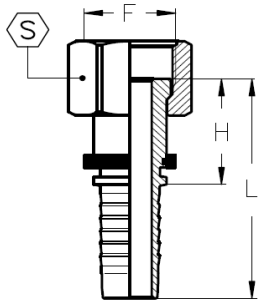

Modellen:

Bestelnummer	slangmaat	F UNF	H	L	S	max. werkdruk bar*
C09ORFS-04	1/4	9/16	22,5	55	17	450
C11ORFS-04	1/4	11/16	25	53	22	450
C11ORFS-05	5/16	11/16	25	53	22	350
C11ORFS-06	3/8	11/16	24,5	55	22	450
C13ORFS-06	3/8	13/16	28,5	59	24	450
C13ORFS-08	1/2	13/16	28,5	61,5	24	415
C16ORFS-08	1/2	1	33	86	30	415
C19ORFS-08	1/2	1 3/16	35,5	68,5	36	415
C16ORFS-10	5/8	1	33	68,5	30	350
C19ORFS-10	5/8	1 3/16	35,5	71,5	36	350
C19ORFS-12	3/4	1 3/16	37,5	78	36	350
C23ORFS-12	3/4	1 7/16	39	79,5	41	350
C23ORFS-16	1	1 7/16	39,5	90,5	41	280
C27ORFS-20	1 1/4	1 11/16	40	91	50	280

ORFS 45° wartelkoppeling vlakke afdichting type ORFS45

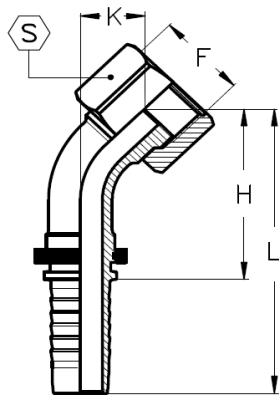

Modellen:

Bestelnummer	slangmaat	F UNF	H	L	K	S	max. werkdruk bar*
C09ORFS45-04	1/4	9/16	32,5	60,5	10,5	17	450
C11ORFS45-04	1/4	11/16	34,5	62,5	12,5	22	450
C11ORFS45-05	5/16	11/16	35	63	12,5	22	350
C11ORFS45-06	3/8	11/16	36	66,5	12,5	22	450
C13ORFS45-06	3/8	13/16	38,5	69	15	24	450
C13ORFS45-08	1/2	13/16	42,5	75,5	15,5	24	415
C16ORFS45-08	1/2	1	45	78	17,5	30	415
C19ORFS45-08	1/2	1 3/16	47	80	20,5	36	415
C16ORFS45-10	5/8	1	49	85	18	30	350
C19ORFS45-10	5/8	1 3/16	51,5	87,5	20,5	36	350
C19ORFS45-12	3/4	1 3/16	58	99	21	36	350
C23ORFS45-12	3/4	1 7/16	60,5	101	23,5	41	350
C23ORFS45-16	1	1 7/16	73	124	24	41	280
C27ORFS45-20	1 1/4	1 11/16	75	126	26,5	50	280

* Attentie: let ook op de maximale werkdruk van de slang.

ORFS 90° wartelkoppeling vlakke afdrichting type ORFS90

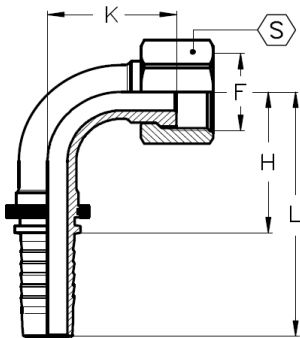

Modellen:

Bestelnummer	slangmaat	F UNF	H	L	K	S	max. werkdruk bar*
C09ORFS90-04	1/4	9/16	27	55	21	17	450
C11ORFS90-04	1/4	11/16	27	55	24	22	450
C11ORFS90-05	5/16	11/16	29	57	25	22	350
C11ORFS90-06	3/8	11/16	31,5	62	24,5	22	450
C13ORFS90-06	3/8	13/16	31	61	30	24	450
C13ORFS90-08	1/2	13/16	39	72	31	24	415
C16ORFS90-08	1/2	1	39	72	34	30	415
C19ORFS90-08	1/2	1 3/16	39	72	42	36	415
C16ORFS90-10	5/8	1	45	81	35	30	350
C19ORFS90-10	5/8	1 3/16	45	81	42	36	350
C19ORFS90-12	3/4	1 3/16	55	95	45	36	350
C23ORFS90-12	3/4	1 7/16	55	95	49	41	350
C23ORFS90-16	1	1 7/16	71	122	55	41	350
C27ORFS90-20	1 1/4	1 11/16	86	143	63	50	210

ORFS koppeling met uitwendige draad, vlakke afdrichting type ORMS (exclusief O-ring)

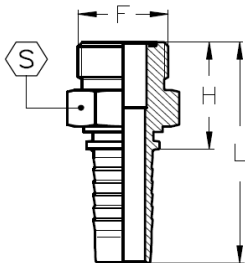

Modellen:

Bestelnummer	slangmaat	F UNF	H	L	S	O-ring	max. werkdruk bar*
C09ORMS-04	1/4	9/16	23,5	51,5	17	OR7,66X1,78	450
C11ORMS-04	1/4	11/16	25,5	53,5	19	OR9,25X1,78	450
C11ORMS-05	5/16	11/16	25,5	53,5	19	OR9,25X1,78	350
C11ORMS-06	3/8	11/16	25,5	56	19	OR9,25X1,78	450
C13ORMS-06	3/8	13/16	28,5	59	22	OR12,42X1,78	450
C16ORMS-06	3/8	1	33	63,5	27	OR15,6X1,78	450
C13ORMS-08	1/2	13/16	29,5	62,5	27	OR12,42X1,78	415
C16ORMS-08	1/2	1	34	67	27	OR15,6X1,78	415
C19ORMS-08	1/2	1 3/16	37	70	32	OR18,77X1,78	415
C16ORMS-10	5/8	1	34	70	27	OR15,6X1,78	350
C19ORMS-10	5/8	1 3/16	37	73	32	OR18,77X1,78	350
C19ORMS-12	3/4	1 3/16	38	78,5	32	OR18,77X1,78	350
C23ORMS-12	3/4	1 7/16	42,5	83	41	OR23,52X1,78	350
C23ORMS-16	1	1 7/16	44	95	41	OR18,77X1,78	280
C27ORMS-20	1 1/4	1 11/16	46	104	46	OR29,87X1,78	210

* Attentie: let ook op de maximale werkdruk van de slang.

Slangkoppeling voor snijringmontage type P

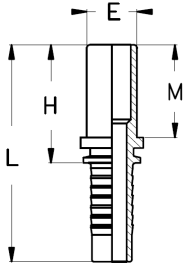

Modellen:

Bestelnummer	slangmaat	leiding maat E	H	L	M	max. werkdruk bar*
C06P-03	3/16	6L/S	27	52	21	415
C08P-03	3/16	8L/S	29	54	23	415
C06P-04	1/4	6L	27,5	55,5	21	280
C08P-04	1/4	8L/S	29,5	57,5	23	450
C10P-04	1/4	10L/S	31,5	59,5	25	450
C12P-04	1/4	12L/S	32	60	25	450
C10P-05	5/16	10L/S	31,5	59,5	25	350
C12P-05	5/16	12L/S	31,5	59,5	25	350
C10P-06	3/8	10L	28,5	59	22	350
C12P-06	3/8	12L/S	31,5	62	25	445
C14P-06	3/8	14S	34,5	65	28	445
C15P-06	3/8	15L	30,5	61	24	280
C12P-08	1/2	12L/S	32,5	65,5	25	415
C14P-08	1/2	14S	35,5	68,5	28	415
C15P-08	1/2	15L	31,5	64,5	24	280
C16P-08	1/2	16S	36,5	69,5	29	415
C18P-08	1/2	18L	33,5	66,5	26	210
C18P-10	5/8	18L	33,5	69,5	26	210
C20P-10	5/8	20S	42,5	78,5	35	350
C22P-10	5/8	22L	35,5	71,5	28	210
C18P-12	3/4	18L	35	75,5	26	210
C20P-12	3/4	20S	44	84,5	35	350
C22P-12	3/4	22L	37	77,5	28	210
C25P-12	3/4	25S	48	88,5	39	350
C25P-16	1	25S	49,5	100,5	39	280
C28P-16	1	28L	39,5	90,5	29	165
C30P-16	1	30S	53,5	104,5	43	280
C30P-20	1 1/4	30S	54	111,5	43	210
C35P-20	1 1/4	35L	46	103,5	35	125
C38P-20	1 1/4	38S	59	116,5	48	210
C35P-24	1 1/2	35L	56	123	43	100
C38P-24	1 1/2	38S	59,5	124	48	185
C42P-24	1 1/2	42L	47,5	112	36	100

* Attentie: let ook op de maximale werkdruk van de slang.

Slangkoppeling 45° voor snijringmontage type P45

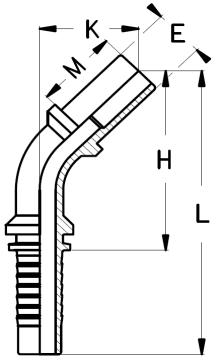

Modellen:

Bestelnummer	slangmaat	leiding maat E	H	L	K	M	max. werkdruk bar*
C06P45-03	3/16	6L/S	40	65	21	21	415
C08P45-03	3/16	8L/S	41	66	22	23	415
C06P45-04	1/4	6L	44	72	24	21	280
C08P45-04	1/4	8L/S	44	72	24	23	450
C10P45-04	1/4	10L/S	46	74	25	25	450
C12P45-04	1/4	12L/S	47	75	26	25	450
C10P45-05	5/16	10L/S	48	76	26	25	350
C12P45-05	5/16	12L/S	48	76	26	25	350
C10P45-06	3/8	10L	49	80	26	22	350
C12P45-06	3/8	12L/S	50	80	27	25	445
C14P45-06	3/8	14S	52	82	29	28	445
C15P45-06	3/8	15L	49	80	26	24	280
C14P45-08	1/2	14S	58	91	31	28	415
C15P45-08	1/2	15L	55	88	28	24	280
C16P45-08	1/2	16S	58	91	32	29	415
C18P45-08	1/2	18L	56	89	30	26	210
C18P45-10	5/8	18L	62	98	31	26	210
C20P45-10	5/8	20S	68	104	37	35	350
C22P45-10	5/8	22L	61	97	30	28	210
C20P45-12	3/4	20S	76	117	39	35	350
C22P45-12	3/4	22L	71	112	34	28	210
C25P45-12	3/4	25S	79	119	41	39	350
C25P45-16	1	25S	101	152	52	39	280
C28P45-16	1	28L	94	145	45	29	165
C30P45-16	1	30S	97	148	48	43	280
C35P45-20	1 1/4	35L	110	168	53	35	125
C38P45-20	1 1/4	38S	113	171	56	48	210
C38P45-24	1 1/2	38S	133	197	65	48	185
C42P45-24	1 1/2	42L	124	189	56	36	100

* Attentie: let ook op de maximale werkdruk van de slang.

Slangkoppeling 90° voor snijringmontage type P90

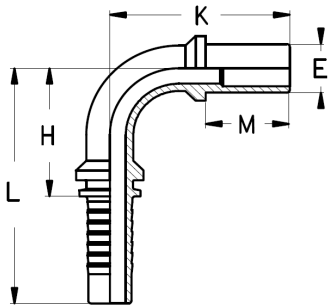

Modellen:

Bestelnummer	slangmaat	leiding maat E	H	L	K	M	max. werkdruk bar*
C06P90-03	3/16	6L/S	21	46	34	21	415
C08P90-03	3/16	8L/S	21	46	36	23	415
C06P90-04	1/4	6L/S	26	54	39	21	280
C08P90-04	1/4	8L/S	26	54	39	23	450
C10P90-04	1/4	10L/S	26	54	41	25	450
C12P90-04	1/4	12L/S	26	54	43	25	450
C10P90-05	5/16	10L/S	28	56	44	25	350
C12P90-05	5/16	12L/S	28	56	44	25	350
C10P90-06	3/8	10L/S	31	61	45	22	350
C12P90-06	3/8	12L/S	31	61	46	25	445
C14P90-06	3/8	14S	31	61	49	28	445
C15P90-06	3/8	15L	31	61	45	24	280
C16P90-06	3/8	16S	43	73	55	32	415
C14P90-08	1/2	14S	38	71	55	28	415
C15P90-08	1/2	15L	38	71	51	24	280
C16P90-08	1/2	16S	38	71	56	29	415
C18P90-08	1/2	18L	38	71	53	26	210
C18P90-10	5/8	18L	45	80	57	26	210
C20P90-10	5/8	20S	45	80	66	35	350
C22P90-10	5/8	22L	45	80	56	28	210
C20P90-12	3/4	20S	54	95	70	35	350
C22P90-12	3/4	22L	54	95	64	28	210
C25P90-12	3/4	25S	54	95	75	39	350
C25P90-16	1	25S	70	121	96	39	280
C28P90-16	1	28L	70	121	86	29	165
C30P90-16	1	30S	70	121	90	43	280
C30P90-20	1 1/4	30S	84	142	103	43	210
C35P90-20	1 1/4	35L	84	142	100	35	125
C38P90-20	1 1/4	38S	84	142	105	48	210
C35P90-24	1 1/2	35L	73	138	95	48	125
C38P90-24	1 1/2	38S	100	165	123	48	185
C42P90-24	1 1/2	42L	100	165	111	36	100

* Attentie: let ook op de maximale werkdruk van de slang.

SAE Flens 3000PSI type X3 (exclusief O-ring)

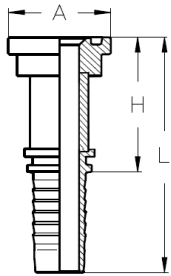

Modellen:

Bestelnummer	slangmaat	Flens	H	L	A	max. werkdruk bar*
C10X3-08	1/2	5/8	52	85	34	350
C12X3-08**	1/2	3/4	52	85	38,1	350
C10X3-10	5/8	5/8	52	88	34	350

**uitlopend model

SAE Flens 3000PSI uit een stuk type X3-ES (exclusief O-ring)

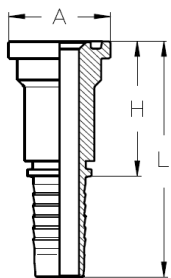

Modellen:

Bestelnummer	slangmaat	Flens	H	L	A	max. werkdruk bar*
C08X3-08 ES	1/2	1/2	47	80	30,2	350
C12X3-08 ES	1/2	3/4	47	80	38,1	350
C12X3-10 ES	5/8	3/4	48	84	34	350
C12X3-12 ES	3/4	3/4	54	94,5	38,1	350
C16X3-12 ES	3/4	1	54	94,5	44,5	350
C12X3-16 ES	1	3/4	55	106	38,1	280
C16X3-16 ES	1	1	55	106	44,5	280
C20X3-16 ES	1	1 1/4	55	106	50,8	280
C20X3-20 ES	1 1/4	1 1/4	62	120	50,8	210
C24X3-20 ES	1 1/4	1 1/2	62	120	60,3	210
C24X3-24 ES	1 1/2	1 1/2	67,5	132	60,3	185
C32X3-24 ES	1 1/2	2	67,5	132	71,4	185
C32X3-32 ES	2	2	70	140	71,4	175

SAE 45° Flens 3000PSI type X345 (exclusief O-ring)

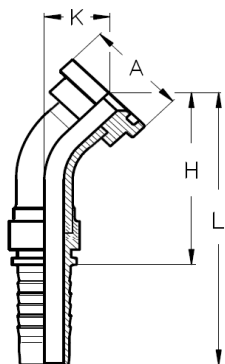

Modellen:

Bestelnummer	slangmaat	Flens	H	L	K	A	max. werkdruk bar*
C10X345-08	1/2	5/8	51	90	24	34	350
C12X345-08**	1/2	3/4	49	82	22	38,1	350
C10X345-10	5/8	5/8	73	110	29	34	350
C20X345-20**	1 1/4	1 1/4	72	137	30	50,8	210
C32X345-24**	1 1/2	2	106	173	42	71,4	185
C32X345-32**	2	2	108	180	42	71,4	175

**uitlopend model

Voor SAE afdichtringen zie pagina 3M.30

* Attentie: let ook op de maximale werkdruk van de slang.

SAE 45° Flens uit een stuk 3000PSI type X345-ES (exclusief O-ring)

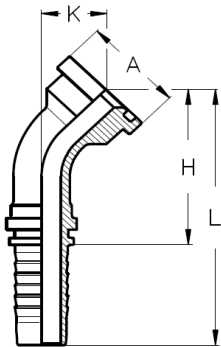

Modellen:

Bestelnummer	slangmaat	Flens	H	L	K	A	max. werkdruk bar*
C08X345-08 ES	1/2	1/2	47	80	20	30,2	350
C12X345-08 ES	1/2	3/4	51	84	24	38,1	350
C12X345-10 ES	5/8	3/4	55	91	24	38,1	350
C12X345-12 ES	3/4	3/4	62	102	25	38,1	350
C16X345-12 ES	3/4	1	64	104	27	44,5	350
C16X345-16 ES	1	1	77	128	28	44,5	280
C20X345-16 ES	1	1 1/4	77	128	28	50,8	280
C20X345-20 ES	1 1/4	1 1/4	88	146	32	50,8	210
C24X345-20 ES	1 1/4	1 1/2	88	146	32	60,3	210

SAE 90° Flens 3000PSI type X390 (exclusief O-ring)

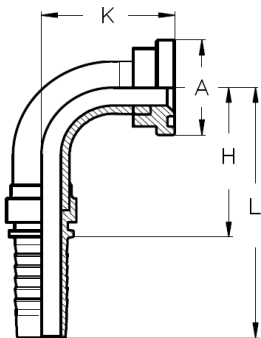

Modellen:

Bestelnummer	slangmaat	Flens	H	L	K	A	max. werkdruk bar*
C10X390-08	1/2	5/8	50	82	45	34	350
C10X390-10	5/8	5/8	48	80	48	34	350
C20X390-20**	1 1/4	1 1/4	63	128	65	50,8	210
C32X390-32**	2	2	102	183	100	71,4	175

**uitlopend model

SAE 90° Flens 3000PSI uit een stuk type X390-ES (exclusief O-ring)

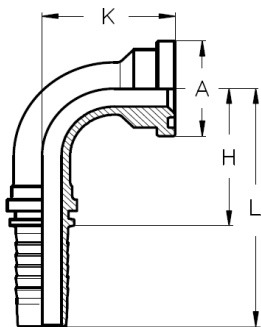

Modellen:

Bestelnummer	slangmaat	Flens	H	L	K	A	max. werkdruk bar*
C08X390-08 ES	1/2	1/2	38	71	40	30,2	350
C12X390-08 ES	1/2	3/4	38	71	45	38,1	350
C12X390-10 ES	5/8	3/4	45	81	47	38,1	350
C12X390-12 ES	3/4	3/4	55	95	51	38,1	350
C16X390-12 ES	3/4	1	55	95	54	44,5	280
C12X390-16 ES	1	3/4	70	121	65	38,1	280
C16X390-16 ES	1	1	70	121	61	44,5	280
C20X390-16 ES	1	1 1/4	70	121	61	50,8	280
C20X390-20 ES	1 1/4	1 1/4	85	142	70	50,8	210
C24X390-20 ES	1 1/4	1 1/2	85	142	70	60,3	185
C24X390-24 ES	1 1/2	1 1/2	103	170	83	60,3	185

Voor SAE afdichtingen zie pagina 3M.30

* Attentie: let ook op de maximale werkdruk van de slang.

SAE Flens 6000PSI uit een stuk type X6-ES (exclusief O-ring)

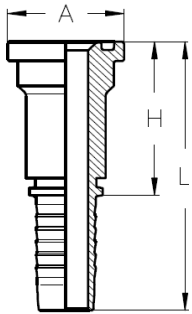

Modellen:

Bestelnummer	slangmaat	Flens	H	L	A	max. werkdruk bar*
C08X6-08 ES	1/2	1/2	47	80	31,8	415
C12X6-08 ES	1/2	3/4	47	80	41,3	415
C08X6-10 ES	5/8	1/2	48	84	31,8	350
C12X6-10 ES	5/8	3/4	48	84	41,3	350
C08X6-12 ES	3/4	1/2	50	90,5	31,8	350
C12X6-12 ES	3/4	3/4	58	98,5	41,3	350
C16X6-12 ES	3/4	1	58	98,5	47,6	350
C12X6-16 ES	1	3/4	60	115	41,3	280
C16X6-16 ES	1	1	64	115	47,6	280
C20X6-16 ES	1	1 1/4	64	115	54	280
C20X6-20 ES	1 1/4	1 1/4	67,5	125	54	210
C24X6-20 ES	1 1/4	1 1/2	67,5	125	63,5	185
C24X6-24 ES	1 1/2	1 1/2	79,5	144	63,5	185
C32X6-32 ES	2	2	95	165	79,4	175

SAE 45° Flens 6000PSI uit een stuk type X645-ES (exclusief O-ring)

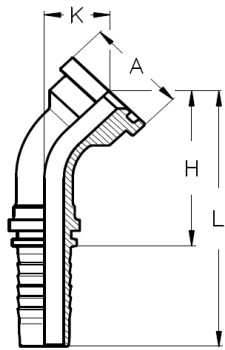

Modellen:

Bestelnummer	slangmaat	Flens	H	L	K	A	max. werkdruk bar*
C08X645-08 ES	1/2	1/2	47	80	20	31,8	415
C12X645-08 ES	1/2	3/4	53	86	26	41,3	415
C08X645-10 ES	5/8	1/2	51	87	21	31,8	350
C12X645-10 ES	5/8	3/4	57	93	26	41,3	350
C08X645-12 ES	3/4	1/2	64	104	26	31,8	350
C12X645-12 ES	3/4	3/4	64	104	26	41,3	280
C16X645-12 ES	3/4	1	68	108	31	47,6	350
C12X645-16 ES	1	3/4	79	130	31	41,3	280
C16X645-16 ES	1	1	80	131	32	47,6	280
C20X645-16 ES	1	1 1/4	85	136	37	54	280
C20X645-20 ES	1 1/4	1 1/4	93	151	37	54	210
C24X645-20 ES	1 1/4	1 1/2	99	157	43	63,5	210
C24X645-24 ES	1 1/2	1 1/2	111	175	55	63,5	185

Voor SAE afdichtringen zie pagina 3M.30

* Attentie: let ook op de maximale werkdruk van de slang.

SAE 90° Flens 6000PSI uit een stuk type X690-ES (exclusief O-ring)

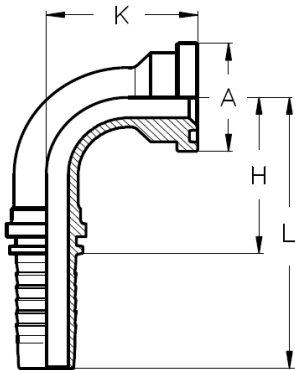

Modellen:

Bestelnummer	slangmaat	Flens	H	L	K	A	max. werkdruk bar*
C08X690-08 ES	1/2	1/2	38	71	40	31,8	415
C12X690-08 ES	1/2	3/4	38	71	47	41,3	415
C08X690-10 ES	5/8	1/2	45	81	42	31,8	350
C12X690-10 ES	5/8	3/4	45	81	50	41,3	350
C08X690-12 ES	3/4	1/2	55	95	54	31,8	350
C12X690-12 ES	3/4	3/4	55	95	54	41,3	350
C16X690-12 ES	3/4	1	55	95	60	47,6	350
C12X690-16 ES	1	3/4	70	121	65	41,3	280
C16X690-16 ES	1	1	70	121	66	47,6	280
C20X690-16 ES	1	1 1/4	70	121	73	54	280
C20X690-20 ES	1 1/4	1 1/4	85	142	78	54	210
C24X690-20 ES	1 1/4	1 1/2	85	142	86	63,5	185
C24X690-24 ES	1 1/2	1 1/2	105	170	93	63,5	210

Montageflens t.b.v. SAE flensen 3000PSI per set van twee stuks XCH3

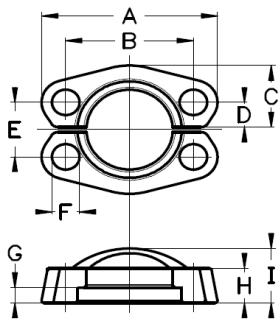

Modellen:

Bestelnummer	t.b.v. Flens	A	B	C	D	E	F	G	H	I
C08XCH3	1/2	54	38,1	21,8	8	17,5	9	6,2	13	19
C12XCH3	3/4	65	47,6	24,9	10	22,3	11	6,2	14	22
C16XCH3	1	69,8	52,4	28,2	12	26,2	11	7,5	16	24
C20XCH3	1 1/4	79,4	58,7	35,3	14	30,2	11	7,5	16	25
C24XCH3	1 1/2	93,7	69,9	40,1	17	35,7	13	7,5	16	25
C32XCH3	2	101,6	77,8	47,2	21	42,9	13	9	16	26

Montageflens t.b.v. SAE flensen 6000PSI per set van twee stuks XCH6

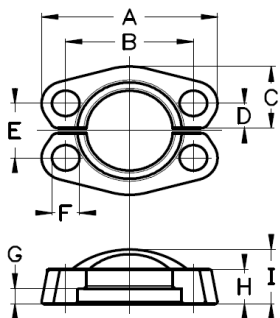

Modellen:

Bestelnummer	t.b.v. Flens	A	B	C	D	E	F	G	H	I
C08XCH6	1/2	56,3	40,5	22,6	8	18,2	9	7,2	16	22
C12XCH6	3/4	71,4	50,8	29	11	23,8	11	8,2	19	28
C16XCH6	1	80,9	57,2	33,8	13	27,8	13	9	24	33
C20XCH6	1 1/4	95,2	66,6	37,6	15	31,8	15	9,8	17	38
C24XCH6	1 1/2	112,7	79,3	46,5	17	36,5	17	12	30	43
C32XCH6	2	133,4	96,8	55,9	21	44,5	22	12	37	52

Voor SAE afdichtringen zie pagina 3M.30

* Attentie: let ook op de maximale werkdruk van de slang.

O-ring voor SAE flensen 3000 & 6000PSI 90 shore



Modellen:

Bestelnummer	t.b.v. Flens
SAE3/6-008/16	1/2
SAE3/6-012/16	3/4
SAE3/6-016/16	1
SAE3/6-020/16	1 1/4
SAE3/6-024/16	1 1/2
SAE3/6-032/16	2

Afdichtring voor SAE flensen 3000 & 6000PSI



Modellen:

Bestelnummer	t.b.v. Flens
SAE3/6-SFS-08	1/2
SAE3/6-SFS-12	3/4
SAE3/6-SFS-16	1
SAE3/6-SFS-20	1 1/4
SAE3/6-SFS-24	1 1/2

* Attentie: let ook op de maximale werkdruk van de slang.

SUPERCAT flenskoppeling type YP

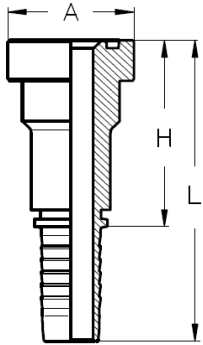

Modellen:

Bestelnummer	slangmaat	Flens	H	L	A	max. werkdruk bar*
C12YP-12 ES	3/4	3/4	66	106,5	41,3	350
C16YP-16 ES	1	1	68	108,5	47,6	350

SUPERCAT 45° flenskoppeling type YP45

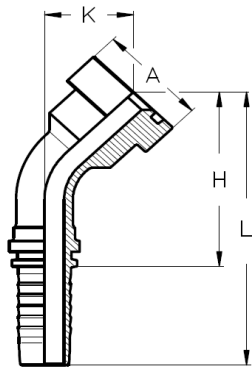

Modellen:

Bestelnummer	slangmaat	Flens	H	L	K	A	max. werkdruk bar*
C12YP45-12 ES	3/4	3/4	71	112	34	41,3	350
C16YP45-16 ES	1	1	74	114	36	47,6	350

SUPERCAT 45° flenskoppeling type YP90

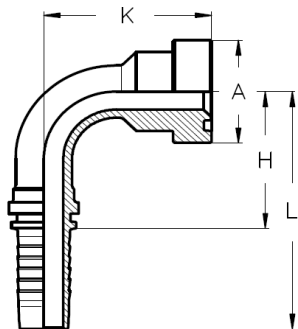

Modellen:

Bestelnummer	slangmaat	Flens	H	L	K	A	max. werkdruk bar*
C12YP90-12 ES	3/4	3/4	55	95	64	41,3	350
C16YP90-16 ES	1	1	55	95	67	47,6	350

O-ring of Afdichtring voor SUPERCAT flensen



Modellen O-ring:

Bestelnummer	t.b.v. Flens
SAE3/6-008/16	1/2
SAE3/6-012/16	3/4
SAE3/6-016/16	1
SAE3/6-020/16	1 1/4
SAE3/6-024/16	1 1/2
SAE3/6-032/16	2



Modellen Afdichtring:

Bestelnummer	t.b.v. Flens
SAE3/6-SFS-08	1/2
SAE3/6-SFS-12	3/4
SAE3/6-SFS-16	1
SAE3/6-SFS-20	1 1/4
SAE3/6-SFS-24	1 1/2

* Attentie: let ook op de maximale werkdruk van de slang.

Pershuls NON-SKIVE (niet schillen) type BXC

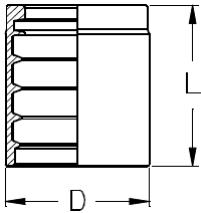

Modellen:

Bestelnummer	slangmaat	D	L	Toepasbaar op slangtype
CF-04 BXC	1/4	19	23	1SC
CF-05 BXC	5/16	20	27,5	1SC
CF-06 BXC	3/8	23	30	1SC
CF-08 BXC	1/2	26,5	32	1SC
CF-10 BXC	5/8	29	35	1SC
CF-12 BXC	3/4	33	34	1SC
CF-16 BXC	1	42	45	1SC

Pershuls NON-SKIVE (niet schillen) type 1-BXT

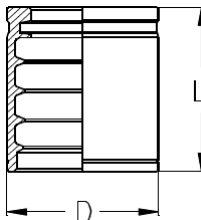

Modellen:

Bestelnummer	slangmaat	D	L	Toepasbaar op slangtypes		
CF-031 BXT	3/16	19	24	1SN	R1AT	
CF-041 BXT	1/4	20	27	1SN	R1AT	2SC
CF-051 BXT	5/16	22	27,5	1SN	R1AT	2SC
CF-061 BXT	3/8	24,5	30	1SN	R1AT	2SC
CF-081 BXT	1/2	28	32,5	1SN	R1AT	2SC
CF-101 BXT	5/8	32	35	1SN	R1AT	2SC
CF-121 BXT	3/4	36	40	1SN	R1AT	2SC
CF-161 BXT	1	45	50	1SN	R1AT	2SC

Pershuls NON-SKIVE (niet schillen) type 2-BXT

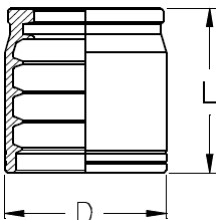

Modellen:

Bestelnummer	slangmaat	D	L	Toepasbaar op slangtypes				
CF-042 BXT	1/4	22	26	2SN	R2AT	1SN	R1AT	2SC
CF-052 BXT	5/16	24	27,5	2SN	R2AT	1SN	R1AT	2SC
CF-062 BXT	3/8	26	30	2SN	R2AT	1SN	R1AT	2SC
CF-082 BXT	1/2	30	32,5	2SN	R2AT	1SN	R1AT	2SC
CF-102 BXT	5/8	34	35	2SN	R2AT	1SN	R1AT	2SC
CF-122 BXT	3/4	38	40	2SN	R2AT	1SN	R1AT	2SC
CF-162 BXT	1	48	50	2SN	R2AT			

Pershuls SKIVE (schillen) type BXLP

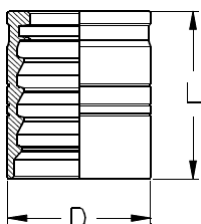

Modellen:

Bestelnummer	slangmaat	D	L	Toepasbaar op slangtypes				
CF-03 BXLP	3/16	17	26	1SN	R1AT	2SN	R2AT	
CF-04 BXLP	1/4	19	29	1SN	R1AT	2SN	R2AT	2SC
CF-05 BXLP	5/16	21	29	1SN	R1AT	2SN	R2AT	2SC
CF-06 BXLP	3/8	23	31,5	1SN	R1AT	2SN	R2AT	2SC
CF-08 BXLP	1/2	27	34	1SN	R1AT	2SN	R2AT	2SC
CF-10 BXLP	5/8	32	37	1SN	R1AT	2SN	R2AT	2SC
CF-12 BXLP	3/4	36	43	1SN	R1AT	2SN	R2AT	2SC
CF-16 BXLP	1	44	49	1SN	R1AT	2SN	R2AT	2SC

Pershuls SKIVE (schillen) type BXL

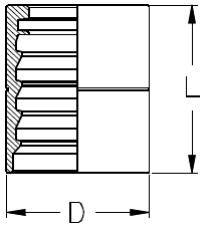

Modellen:

Bestelnummer	slangmaat	D	L	Toepasbaar op slangtypes	
				1SN	R1AT
CF-20 BXL	1 1/4	50	55	1SN	R1AT
CF-24 BXL	1 1/2	57	60	1SN	R1AT
CF-32 BXL	2	70	75	1SN	R1AT

Pershuls NO SKIVE (niet schillen) type BP3

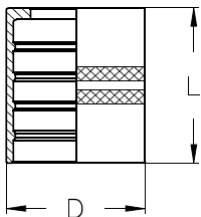

Modellen:

Bestelnummer	slangmaat	D	L	Toepasbaar op slangtypes		
				R3	2TE	3TE
CF-04 BP3	1/4	19	29	R3	2TE	
CF-05 BP3	5/16	22	30	R3	2TE	3TE
CF-06 BP3	3/8	24	31	R3	2TE	3TE
CF-08 BP3	1/2	28,5	34	R3	2TE	3TE
CF-10 BP3	5/8	32	36	R3	2TE	3TE
CF-12 BP3	3/4	38	42	R3	2TE	3TE
CF-16 BP3	1	52	57	R3	2TE	3TE

Pershuls NO SKIVE (niet schillen) type XBP7

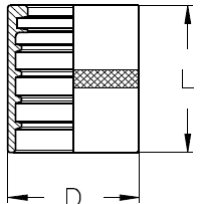

Modellen:

Bestelnummer	slangmaat	D	L	Toepasbaar op slangtypes			
				R7	R8	1TE	
CF-03 XBP7	3/16	15	26		R7	R8	1TE
CF-04 XBP7	1/4	17	29		R7	R8	1TE
CF-05 XBP7	5/16	5/16	20	R6	R7	R8	1TE
CF-06 XBP7	3/8	22	32	R6	R7	R8	1TE
CF-08 XBP7	1/2	27	32,5	R6	R7	R8	1TE
CF-10 XBP7	5/8	31	37	R6	R7	R8	1TE
CF-16 XBP7	1	40	50	R6	R7		1TE

Pershuls SKIVE (schillen) type BXS

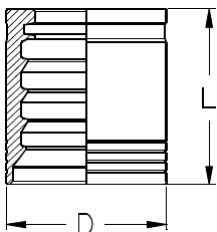

Modellen:

Bestelnummer	slangmaat	D	L	Toepasbaar op slangtypes					
				4SP	R9R	R12	2ST	R2A	
CF-04 BXS	1/4	22	30	4SP					
CF-06 BXS	3/8	26	32,5	4SP	R9R	R12	2ST	R2A	
CF-08 BXS	1/2	30	35	4SP	R9R	R12	2ST	R2A	
CF-10 BXS	5/8	34	38,5	4SP	R9R	R12	2ST	R2A	
CF-12 BXS	3/4	38	43,5	4SP	4SH*	R9R	R12	2ST	R2A
CF-16 BXS	1	46	54	4SP	4SH*	R9R	R12	2ST	R2A
CF-20 BXS	1 1/4	56	61	4SP		R9R	R12	2ST	R2A
CF-24 BXS	1 1/2	65	68	4SP		R9R	R12	2ST	R2A