

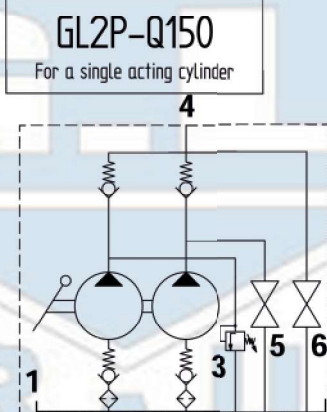

Funzionamento a semplice effetto
-
Single-stroke

GL2P-Q

Descrizione / Codice <i>Description / Code</i>	GL2P-Q 150	GL2P-Q 4VN
Cilindrata 1° Velocità Displacement - 1° Speed (cc)	17	17
Cilindrata 2° Velocità Displacement - 2° Speed (cc)	1	25
Pressione 1° Velocità Pressure - 1° Speed (bar)	100	~25
Pressione 2° Velocità Pressure - 2° Speed (bar)	1500	700
Serbatoio - Oil tank (litre)	1,5	1,5
Mandata - Pressure port	3/8 gas	3/8 gas
Peso - Weight Kg	10	10



Sforzo con leva 430 mm
Working effort with 430 mm hand lever

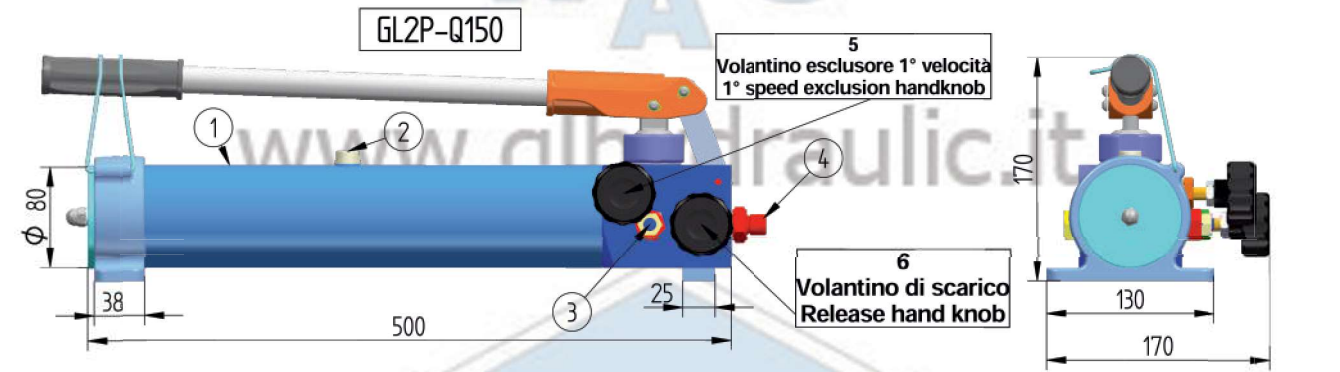
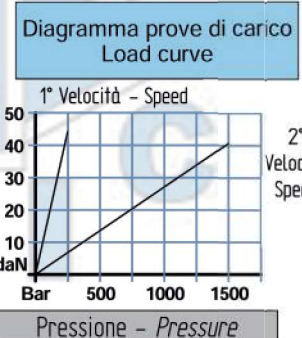

- 1 - Serbatoio 1,5 Litri ; Oil tank 1,5 Lt
- 2 - Tappo carico olio ; Filler plug
- 3 - Valvola di massima pressione ; Relief valve
- 4 - Mandata ; Pressure port

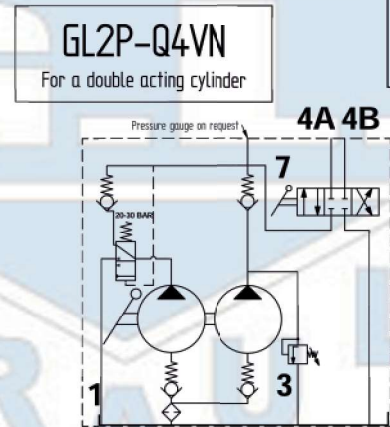
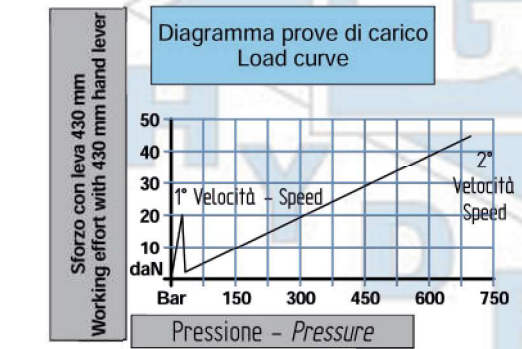
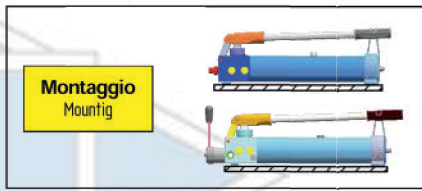

Dati tecnici indicativi e non impegnativi. L'azienda si riserva di apportare modifiche in qualsiasi momento e senza preavviso.
Technical data not binding. Modifications reserved without prior notice.

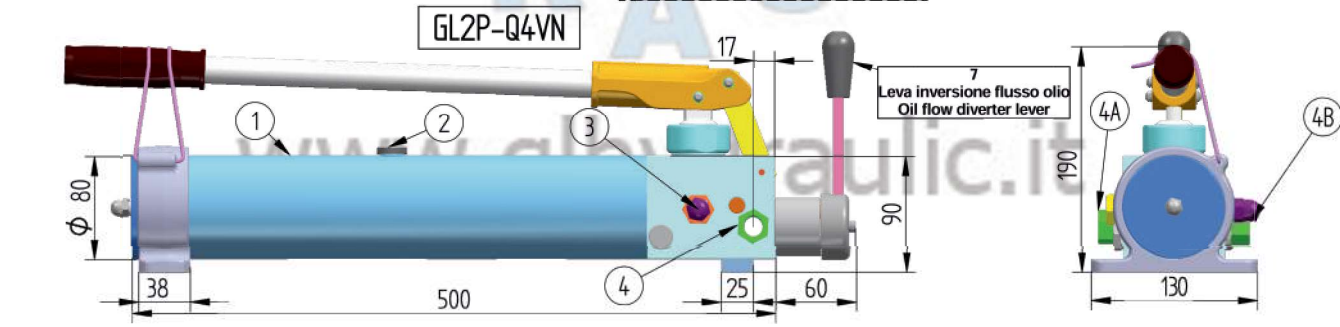

G.L. HYDRAULIC S.R.L.