

Type MY2 802-4

Cod. 4080Y40,75BM5M0000T

Mounting position

IM	B34
IM	2101

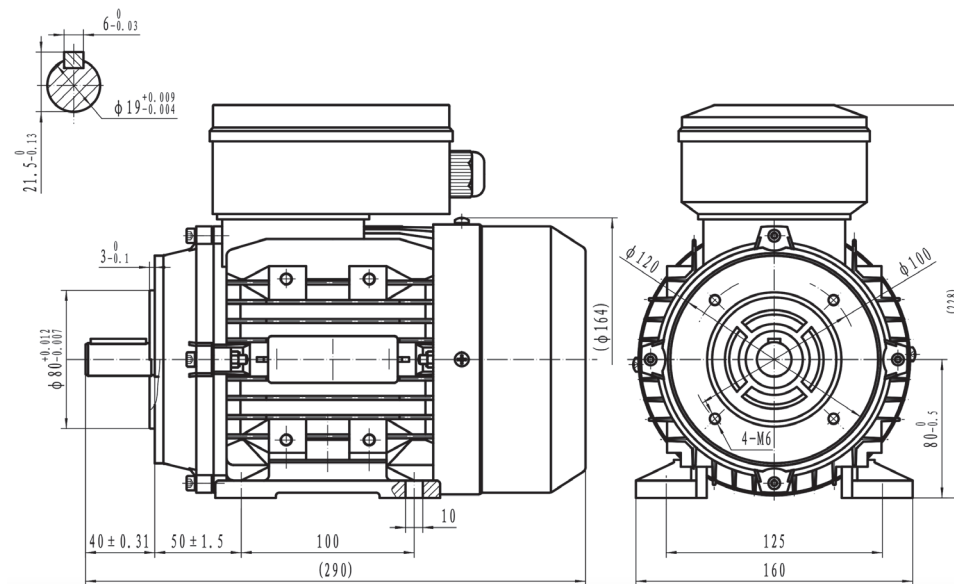

Electrical data			
Rated motor power	0.75		Kw
Rated motor speed	1420		min <sup>-1</sup> 50Hz
Rated motor frequency	50		Hz
Rated motor voltage(+/-10%)	230		V/50Hz
Capacitor	30µf/450V		µF/V
Rated motor torque	5.05		Nm (Mn)
Rated motor current	4.14	V/50Hz	A (In)
Starting motor current	4.1		xIn
Starting motor torque	0.4		xMn
Breakdown motor torque	1.8		xMn
Starting			D.O.L.
Efficiency class	IE2		
Efficiency	50Hz	60Hz	100% load
	79.6	-	75% load
	77.2	-	50% load
Power factor cosφ	0.99	-	100% load

General data		
Frame size	80	
Mounting	B34	
Weight	-	Kg
Casing material	Aluminum	
Protection	IP	55
Insulation class	H	
Tropicalization	Yes	
Vibration class	A	
Duty	S1	
Direction of rotation	CW	
Method of cooling	IC	411
Cable entry	-	
Standards	IEC/DIN/ISO/VDE/EN	
Execute at Standard	IEC 60034-1	
Feet removable	Yes	
Paintwork	7024	C2 standard
Thermal protections	n/a	

Site conditions	
Ambient temperature	from -20°C to +40°C
Altitude above sea level	1000 m

Mechanical data					
Noise level	LpA	70	dB(A)	Bearing DE side	6204-2RS-C3
	LwA	79	dB(A)	Bearing NDE side	6204-2RS-C3
Moment of inertia	0.00208		Kgm <sup>2</sup>	Average bearing lifetime	40000 h
Bearings type			NSK	Relubrication interval L1 DE bearing	life h
Lubricants for bearings	See installation and maintenance manual			Relubrication interval L1 NDE bearing	life h
				Compensation ring	NDE SIDE

There may be differences between rating plate and calculated values.