

CODE	FT1A	
Relief valve Valvola di massima		Pressure range (bar) Campo di taratura
MPC1	A	10 - 60
	B	30 - 150
	C	50 - 250
	D	80 - 360

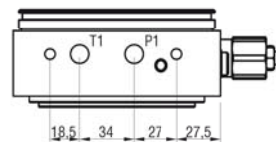
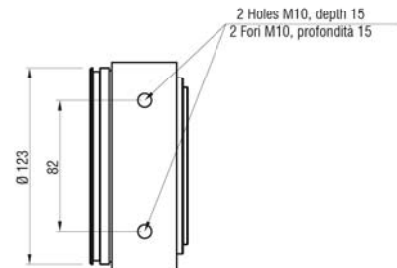
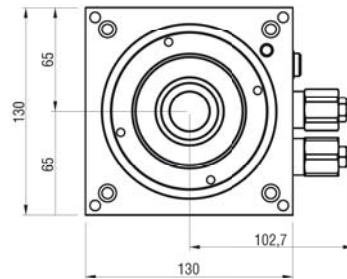
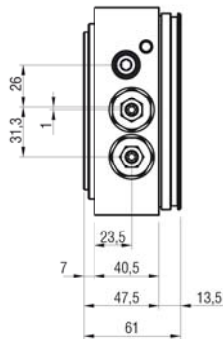
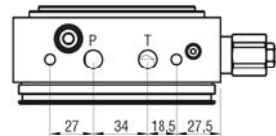
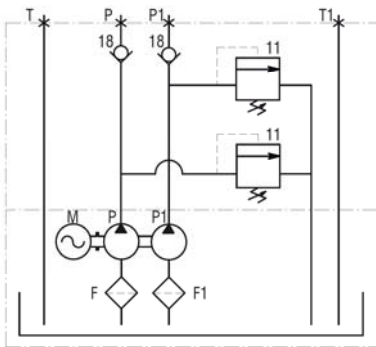
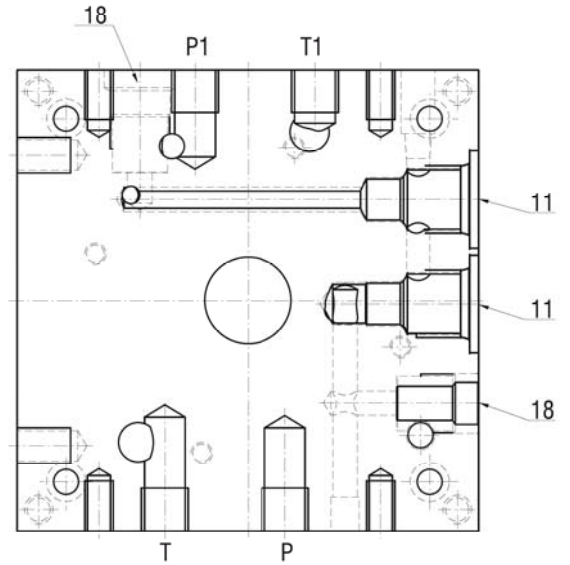

P - T = G 1/4"
P1 - T1 = G 1/4"