

	POTENZA POWER 4500 W	TENSIONE TENSION 24 V	VELOCITA' SPEED 2000 Rpm	COPPIA TORQUE 21.5 Nm	PROTEZIONE ENCLOSURE IP 20	PESO WEIGHT 24 Kg	CODICE CODE CA151.4109.01
--	-----------------------------------	------------------------------------	---------------------------------------	------------------------------------	---	--------------------------------	---

CURVA
CURVE

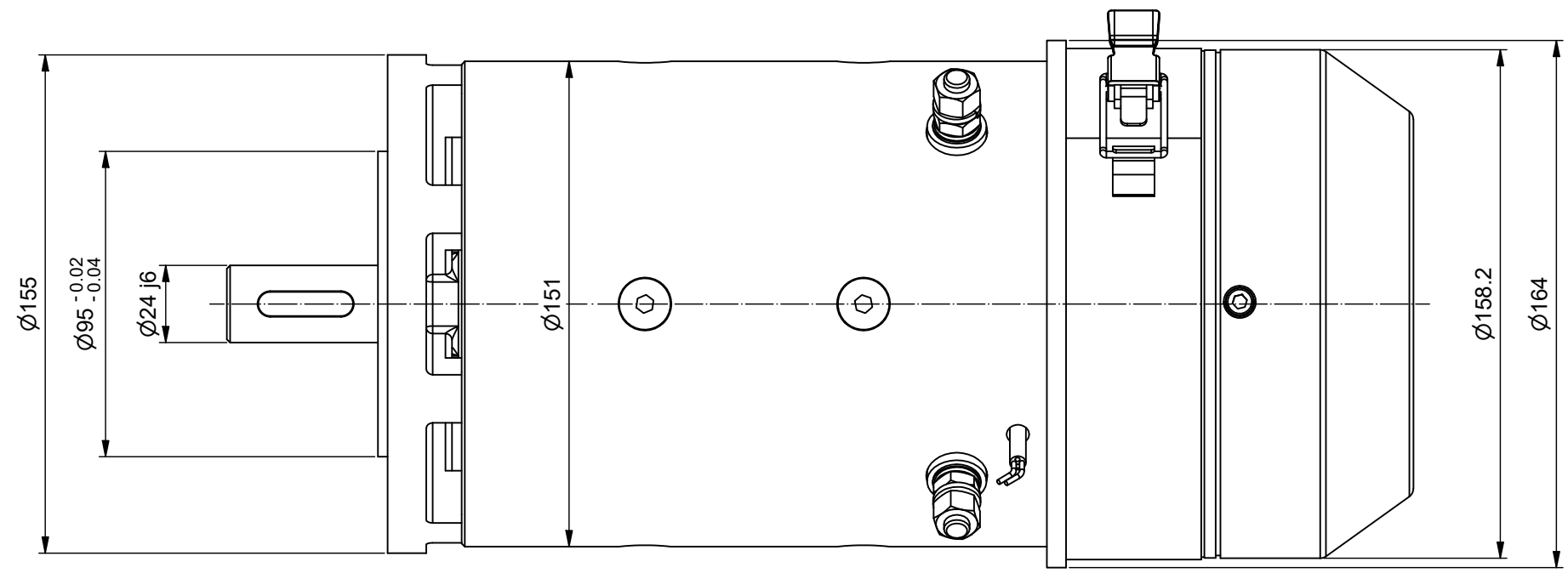
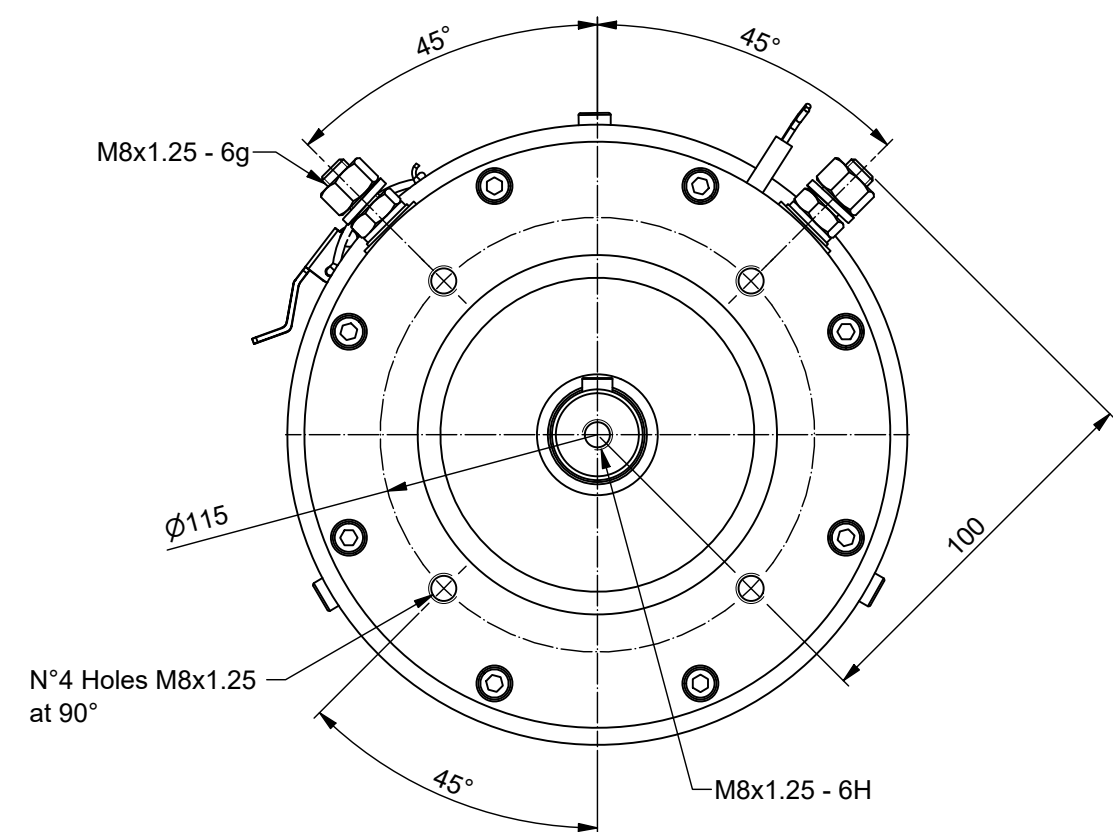
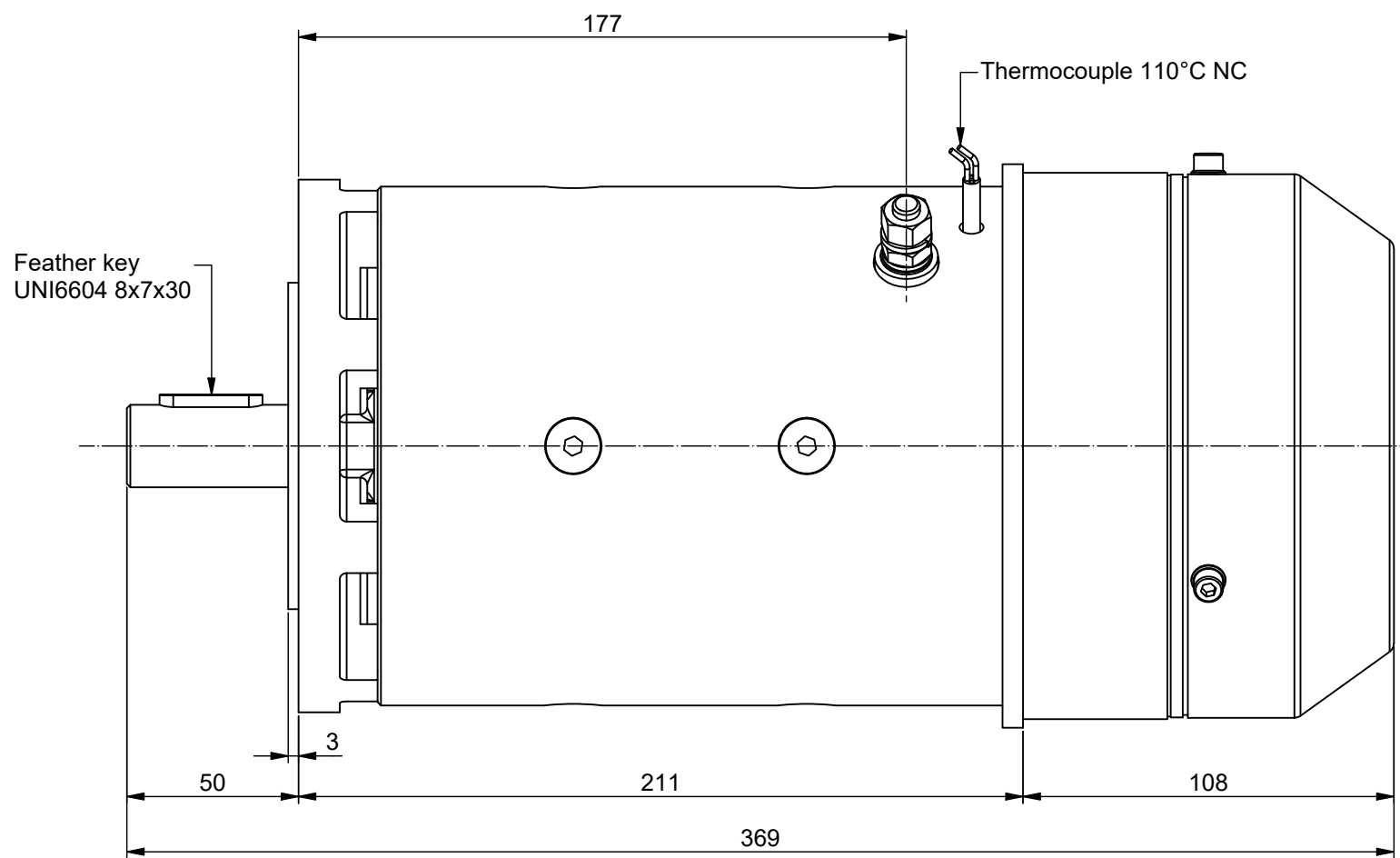

B			
A			
Mod. :	Descrizione :	Firma :	Data Mod. :
Ref. :	Description :	Signature :	Ref. Date :
Tutti i diritti sono riservati. Nessun disegno, o parte di esso, può essere copiato, modificato o trasmesso in qualsiasi forma senza autorizzazione della C.F.R.		All rights reserved. No designs, or part of them, may be copied, modified or transmitted in any form without permission of C.F.R.	
Prodotto :	DC Motor		
Disegnato :	M.P.	Data :	13/03/2026
Drawn :		Scale :	1:3
CA151 - 185 - B14/90 - VP			

A3